

DRIERS-RECEIVER
ACCUMULATORS

RECEIVER/DRIERS

PARTS

DRIERS



400003

| Diam. | Height | Sight Glass | Fuse Plug | Sw.Port |
|-----------|-----------|-------------|-----------|------------|
| 2.50 | 8.00 | Top | | |
| Inlet | Outlet | Moist. Ind. | HPRelief | Gauge Port |
| 3/8" MIOR | 3/8" MIOR | | 7/16-20 | |



404512

| Diam. | Height | Sight Glass | Fuse Plug | Sw.Port |
|-----------|-----------|-------------|-----------|------------|
| 3.00 | 6.44 | Top | | |
| Inlet | Outlet | Moist. Ind. | HPRelief | Gauge Port |
| 3/8" MIOR | 3/8" MIOR | | Yes | 7/16-20 |



404804

| Diam. | Height | Sight Glass | Fuse Plug | Sw.Port |
|----------|----------|-------------|-----------|------------|
| 2.50 | 8.00 | Top | | |
| Inlet | Outlet | Moist. Ind. | HPRelief | Gauge Port |
| 3/8" MFL | 3/8" MFL | | | |

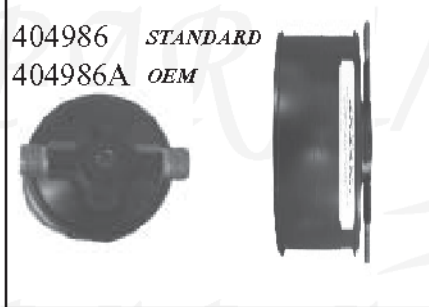

404986 *STANDARD*
404986A *OEM*

| Diam. | Height | Sight Glass | Fuse Plug | Sw.Port |
|-----------|-----------|-------------|-----------|------------|
| 2.75 | 10.00 | Top | | Yes |
| Inlet | Outlet | Moist. Ind. | HPRelief | Gauge Port |
| 3/8" MIOR | 3/8" MIOR | | Yes | |



406092

| Diam. | Height | Sight Glass | Fuse Plug | Sw.Port |
|-----------|-----------|-------------|-----------|------------|
| 3.00 | 10.00 | Side | | |
| Inlet | Outlet | Moist. Ind. | HPRelief | Gauge Port |
| 3/8" MIOR | 3/8" MIOR | | | |



406152 *STANDARD*
406152A *OEM*

| Diam. | Height | Sight Glass | Fuse Plug | Sw.Port |
|-----------|-----------|-------------|-----------|------------|
| 2.75 | 10.00 | Side | | Yes |
| Inlet | Outlet | Moist. Ind. | HPRelief | Gauge Port |
| 3/8" MIOR | 3/8" MIOR | | Yes | |

D712-248



406153 *STANDARD*
406153A *OEM*

| Diam. | Height | Sight Glass | Fuse Plug | Sw.Port |
|-----------|-----------|-------------|-----------|------------|
| 2.75 | 10.00 | Top | Yes | Yes |
| Inlet | Outlet | Moist. Ind. | HPRelief | Gauge Port |
| 3/8" MIOR | 3/8" MIOR | | 7/16-20 | |

D712-225



406154

| Diam. | Height | Sight Glass | Fuse Plug | Sw.Port |
|-----------|-----------|-------------|-----------|------------|
| 2.75 | 10.00 | Yes | | Yes |
| Inlet | Outlet | Moist. Ind. | HPRelief | Gauge Port |
| 3/8" MIOR | 3/8" MIOR | | Yes | |



406157

| Diam. | Height | Sight Glass | Fuse Plug | Sw.Port |
|-----------|-----------|-------------|-----------|------------|
| 2.75 | 10.00 | Yes | | Yes |
| Inlet | Outlet | Moist. Ind. | HPRelief | Gauge Port |
| 3/8" MIOR | 3/8" MIOR | | Yes | |



406158

| Diam. | Height | Sight Glass | Fuse Plug | Sw.Port |
|----------------|-----------|-------------|-----------|---------|
| 3.00 | 8.25 | | | |
| Inlet | Outlet | Moist. Ind. | HPRelief | Gauge |
| Port 3/8" MIOR | 3/8" MIOR | | | |















406159 *STANDARD*
406159A *OEM*

| Diam. | Height | Sight Glass | Fuse Plug | Sw.Port |
|-----------|-----------|-------------|-----------|------------|
| 3.00 | 8.25 | Top | | Yes |
| Inlet | Outlet | Moist. Ind. | HPRelief | Gauge Port |
| 3/8" MIOR | 3/8" MIOR | | Yes | Yes |



406160 *STANDARD*
406160A *OEM*

| Diam. | Height | Sight Glass | Fuse Plug | Sw.Port |
|-----------|-----------|-------------|-----------|------------|
| 3.00 | 8.25 | Side | | Yes |
| Inlet | Outlet | Moist. Ind. | HPRelief | Gauge Port |
| 3/8" MIOR | 3/8" MIOR | | Yes | |

| <p>406161</p>  <table border="1"> <thead> <tr> <th>Diam.</th> <th>Height</th> <th>Sight Glass</th> <th>Fuse Plug</th> <th>Sw.Port.</th> </tr> </thead> <tbody> <tr> <td>2.75</td> <td>10.00</td> <td>Top</td> <td></td> <td>Yes</td> </tr> <tr> <th>Inlet</th> <th>Outlet</th> <th>Moist. Ind.</th> <th>HPRelief</th> <th>Gauge Port</th> </tr> <tr> <td>3/8" MIOR</td> <td>3/8" MIOR</td> <td></td> <td>Yes</td> <td></td> </tr> </tbody> </table> | Diam. | Height | Sight Glass | Fuse Plug | Sw.Port. | 2.75 | 10.00 | Top | | Yes | Inlet | Outlet | Moist. Ind. | HPRelief | Gauge Port | 3/8" MIOR | 3/8" MIOR | | Yes | | <p>406162 <i>STANDARD</i> 406162A <i>OEM</i></p>  <table border="1"> <thead> <tr> <th>Diam.</th> <th>Height</th> <th>Sight Glass</th> <th>Fuse Plug</th> <th>Sw.Port.</th> </tr> </thead> <tbody> <tr> <td>3.00</td> <td>9.00</td> <td>Top</td> <td>Yes</td> <td></td> </tr> <tr> <th>Inlet</th> <th>Outlet</th> <th>Moist. Ind.</th> <th>HPRelief</th> <th>Gauge Port</th> </tr> <tr> <td>3/8" MIOR</td> <td>3/8" MIOR</td> <td></td> <td></td> <td>7/16-20</td> </tr> </tbody> </table> | Diam. | Height | Sight Glass | Fuse Plug | Sw.Port. | 3.00 | 9.00 | Top | Yes | | Inlet | Outlet | Moist. Ind. | HPRelief | Gauge Port | 3/8" MIOR | 3/8" MIOR | | | 7/16-20 | <p>406163</p>  <table border="1"> <thead> <tr> <th>Diam.</th> <th>Height</th> <th>Sight Glass</th> <th>Fuse Plug</th> <th>Sw.Port.</th> </tr> </thead> <tbody> <tr> <td>3.00</td> <td>9.19</td> <td>Top</td> <td></td> <td></td> </tr> <tr> <th>Inlet</th> <th>Outlet</th> <th>Moist. Ind.</th> <th>HPRelief</th> <th>Gauge Port</th> </tr> <tr> <td>3/8" MIOR</td> <td>3/8" MIOR</td> <td></td> <td>Yes</td> <td>Yes 7/16-20</td> </tr> </tbody> </table> | Diam. | Height | Sight Glass | Fuse Plug | Sw.Port. | 3.00 | 9.19 | Top | | | Inlet | Outlet | Moist. Ind. | HPRelief | Gauge Port | 3/8" MIOR | 3/8" MIOR | | Yes | Yes 7/16-20 |
|--|-----------|-------------|-------------|-------------|----------|------|-------|------|--|-----|-------|--------|-------------|----------|------------|-----------|-----------|--|-----|-------------|--|-------|--------|-------------|-----------|----------|------|-------|-----|-----|--|-------|--------|-------------|----------|------------|-----------|-----------|--|-----|-------------|--|-------|--------|-------------|-----------|----------|------|-------|-----|--|--|-------|--------|-------------|----------|------------|-----------|-----------|--|-----|-------------|
| Diam. | Height | Sight Glass | Fuse Plug | Sw.Port. | | | | | | | | | | | | | | | | | | | | | | | | | | | | | | | | | | | | | | | | | | | | | | | | | | | | | | | | | | |
| 2.75 | 10.00 | Top | | Yes | | | | | | | | | | | | | | | | | | | | | | | | | | | | | | | | | | | | | | | | | | | | | | | | | | | | | | | | | | |
| Inlet | Outlet | Moist. Ind. | HPRelief | Gauge Port | | | | | | | | | | | | | | | | | | | | | | | | | | | | | | | | | | | | | | | | | | | | | | | | | | | | | | | | | | |
| 3/8" MIOR | 3/8" MIOR | | Yes | | | | | | | | | | | | | | | | | | | | | | | | | | | | | | | | | | | | | | | | | | | | | | | | | | | | | | | | | | | |
| Diam. | Height | Sight Glass | Fuse Plug | Sw.Port. | | | | | | | | | | | | | | | | | | | | | | | | | | | | | | | | | | | | | | | | | | | | | | | | | | | | | | | | | | |
| 3.00 | 9.00 | Top | Yes | | | | | | | | | | | | | | | | | | | | | | | | | | | | | | | | | | | | | | | | | | | | | | | | | | | | | | | | | | | |
| Inlet | Outlet | Moist. Ind. | HPRelief | Gauge Port | | | | | | | | | | | | | | | | | | | | | | | | | | | | | | | | | | | | | | | | | | | | | | | | | | | | | | | | | | |
| 3/8" MIOR | 3/8" MIOR | | | 7/16-20 | | | | | | | | | | | | | | | | | | | | | | | | | | | | | | | | | | | | | | | | | | | | | | | | | | | | | | | | | | |
| Diam. | Height | Sight Glass | Fuse Plug | Sw.Port. | | | | | | | | | | | | | | | | | | | | | | | | | | | | | | | | | | | | | | | | | | | | | | | | | | | | | | | | | | |
| 3.00 | 9.19 | Top | | | | | | | | | | | | | | | | | | | | | | | | | | | | | | | | | | | | | | | | | | | | | | | | | | | | | | | | | | | | |
| Inlet | Outlet | Moist. Ind. | HPRelief | Gauge Port | | | | | | | | | | | | | | | | | | | | | | | | | | | | | | | | | | | | | | | | | | | | | | | | | | | | | | | | | | |
| 3/8" MIOR | 3/8" MIOR | | Yes | Yes 7/16-20 | | | | | | | | | | | | | | | | | | | | | | | | | | | | | | | | | | | | | | | | | | | | | | | | | | | | | | | | | | |
| <p>406164</p>  <table border="1"> <thead> <tr> <th>Diam.</th> <th>Height</th> <th>Sight Glass</th> <th>Fuse Plug</th> <th>Sw.Port.</th> </tr> </thead> <tbody> <tr> <td>3.00</td> <td>10.13</td> <td>Side</td> <td></td> <td></td> </tr> <tr> <th>Inlet</th> <th>Outlet</th> <th>Moist. Ind.</th> <th>HPRelief</th> <th>Gauge Port</th> </tr> <tr> <td>3/8" MIOR</td> <td>3/8" MIOR</td> <td></td> <td></td> <td></td> </tr> </tbody> </table> | Diam. | Height | Sight Glass | Fuse Plug | Sw.Port. | 3.00 | 10.13 | Side | | | Inlet | Outlet | Moist. Ind. | HPRelief | Gauge Port | 3/8" MIOR | 3/8" MIOR | | | | <p>406165</p>  <table border="1"> <thead> <tr> <th>Diam.</th> <th>Height</th> <th>Sight Glass</th> <th>Fuse Plug</th> <th>Sw.Port.</th> </tr> </thead> <tbody> <tr> <td>3.00</td> <td>10.13</td> <td>Top</td> <td>Yes</td> <td></td> </tr> <tr> <th>Inlet</th> <th>Outlet</th> <th>Moist. Ind.</th> <th>HPRelief</th> <th>Gauge Port</th> </tr> <tr> <td>3/8" MIOR</td> <td>3/8" MIOR</td> <td></td> <td>Yes</td> <td>7/16-20</td> </tr> </tbody> </table> | Diam. | Height | Sight Glass | Fuse Plug | Sw.Port. | 3.00 | 10.13 | Top | Yes | | Inlet | Outlet | Moist. Ind. | HPRelief | Gauge Port | 3/8" MIOR | 3/8" MIOR | | Yes | 7/16-20 | <p>406166</p> <p>MACK</p>  <table border="1"> <thead> <tr> <th>Diam.</th> <th>Height</th> <th>Sight Glass</th> <th>Fuse Plug</th> <th>Sw.Port.</th> </tr> </thead> <tbody> <tr> <td>3.00</td> <td>10.13</td> <td>Top</td> <td></td> <td></td> </tr> <tr> <th>Inlet</th> <th>Outlet</th> <th>Moist. Ind.</th> <th>HPRelief</th> <th>Gauge Port</th> </tr> <tr> <td>3/8" MIOR</td> <td>3/8" MIOR</td> <td></td> <td>Yes</td> <td>Yes M10</td> </tr> </tbody> </table> | Diam. | Height | Sight Glass | Fuse Plug | Sw.Port. | 3.00 | 10.13 | Top | | | Inlet | Outlet | Moist. Ind. | HPRelief | Gauge Port | 3/8" MIOR | 3/8" MIOR | | Yes | Yes M10 |
| Diam. | Height | Sight Glass | Fuse Plug | Sw.Port. | | | | | | | | | | | | | | | | | | | | | | | | | | | | | | | | | | | | | | | | | | | | | | | | | | | | | | | | | | |
| 3.00 | 10.13 | Side | | | | | | | | | | | | | | | | | | | | | | | | | | | | | | | | | | | | | | | | | | | | | | | | | | | | | | | | | | | | |
| Inlet | Outlet | Moist. Ind. | HPRelief | Gauge Port | | | | | | | | | | | | | | | | | | | | | | | | | | | | | | | | | | | | | | | | | | | | | | | | | | | | | | | | | | |
| 3/8" MIOR | 3/8" MIOR | | | | | | | | | | | | | | | | | | | | | | | | | | | | | | | | | | | | | | | | | | | | | | | | | | | | | | | | | | | | | |
| Diam. | Height | Sight Glass | Fuse Plug | Sw.Port. | | | | | | | | | | | | | | | | | | | | | | | | | | | | | | | | | | | | | | | | | | | | | | | | | | | | | | | | | | |
| 3.00 | 10.13 | Top | Yes | | | | | | | | | | | | | | | | | | | | | | | | | | | | | | | | | | | | | | | | | | | | | | | | | | | | | | | | | | | |
| Inlet | Outlet | Moist. Ind. | HPRelief | Gauge Port | | | | | | | | | | | | | | | | | | | | | | | | | | | | | | | | | | | | | | | | | | | | | | | | | | | | | | | | | | |
| 3/8" MIOR | 3/8" MIOR | | Yes | 7/16-20 | | | | | | | | | | | | | | | | | | | | | | | | | | | | | | | | | | | | | | | | | | | | | | | | | | | | | | | | | | |
| Diam. | Height | Sight Glass | Fuse Plug | Sw.Port. | | | | | | | | | | | | | | | | | | | | | | | | | | | | | | | | | | | | | | | | | | | | | | | | | | | | | | | | | | |
| 3.00 | 10.13 | Top | | | | | | | | | | | | | | | | | | | | | | | | | | | | | | | | | | | | | | | | | | | | | | | | | | | | | | | | | | | | |
| Inlet | Outlet | Moist. Ind. | HPRelief | Gauge Port | | | | | | | | | | | | | | | | | | | | | | | | | | | | | | | | | | | | | | | | | | | | | | | | | | | | | | | | | | |
| 3/8" MIOR | 3/8" MIOR | | Yes | Yes M10 | | | | | | | | | | | | | | | | | | | | | | | | | | | | | | | | | | | | | | | | | | | | | | | | | | | | | | | | | | |
| <p>406167 <i>STANDARD</i> 406167A <i>OEM</i></p> <p>WAS D712-264</p>  <table border="1"> <thead> <tr> <th>Diam.</th> <th>Height</th> <th>Sight Glass</th> <th>Fuse Plug</th> <th>Sw.Port.</th> </tr> </thead> <tbody> <tr> <td>2.75</td> <td>10.13</td> <td>Side</td> <td></td> <td></td> </tr> <tr> <th>Inlet</th> <th>Outlet</th> <th>Moist. Ind.</th> <th>HPRelief</th> <th>Gauge Port</th> </tr> <tr> <td>3/8" MIOR</td> <td>3/8" MIOR</td> <td></td> <td>Yes</td> <td>Yes 7/16-20</td> </tr> </tbody> </table> | Diam. | Height | Sight Glass | Fuse Plug | Sw.Port. | 2.75 | 10.13 | Side | | | Inlet | Outlet | Moist. Ind. | HPRelief | Gauge Port | 3/8" MIOR | 3/8" MIOR | | Yes | Yes 7/16-20 | <p>406168 <i>STANDARD</i> 406168A <i>OEM</i></p>  <table border="1"> <thead> <tr> <th>Diam.</th> <th>Height</th> <th>Sight Glass</th> <th>Fuse Plug</th> <th>Sw.Port.</th> </tr> </thead> <tbody> <tr> <td>3.00</td> <td>8.25</td> <td>Top</td> <td></td> <td></td> </tr> <tr> <th>Inlet</th> <th>Outlet</th> <th>Moist. Ind.</th> <th>HPRelief</th> <th>Gauge Port</th> </tr> <tr> <td>3/8" MIOR</td> <td>3/8" FOR</td> <td></td> <td>Yes</td> <td>Yes 7/16-20</td> </tr> </tbody> </table> | Diam. | Height | Sight Glass | Fuse Plug | Sw.Port. | 3.00 | 8.25 | Top | | | Inlet | Outlet | Moist. Ind. | HPRelief | Gauge Port | 3/8" MIOR | 3/8" FOR | | Yes | Yes 7/16-20 | <p>406169</p>  <table border="1"> <thead> <tr> <th>Diam.</th> <th>Height</th> <th>Sight Glass</th> <th>Fuse Plug</th> <th>Sw.Port.</th> </tr> </thead> <tbody> <tr> <td>3.00</td> <td>10.13</td> <td>Top</td> <td></td> <td></td> </tr> <tr> <th>Inlet</th> <th>Outlet</th> <th>Moist. Ind.</th> <th>HPRelief</th> <th>Gauge Port</th> </tr> <tr> <td>3/8" MIOR</td> <td>3/8" FOR</td> <td></td> <td>Yes</td> <td>M10</td> </tr> </tbody> </table> | Diam. | Height | Sight Glass | Fuse Plug | Sw.Port. | 3.00 | 10.13 | Top | | | Inlet | Outlet | Moist. Ind. | HPRelief | Gauge Port | 3/8" MIOR | 3/8" FOR | | Yes | M10 |
| Diam. | Height | Sight Glass | Fuse Plug | Sw.Port. | | | | | | | | | | | | | | | | | | | | | | | | | | | | | | | | | | | | | | | | | | | | | | | | | | | | | | | | | | |
| 2.75 | 10.13 | Side | | | | | | | | | | | | | | | | | | | | | | | | | | | | | | | | | | | | | | | | | | | | | | | | | | | | | | | | | | | | |
| Inlet | Outlet | Moist. Ind. | HPRelief | Gauge Port | | | | | | | | | | | | | | | | | | | | | | | | | | | | | | | | | | | | | | | | | | | | | | | | | | | | | | | | | | |
| 3/8" MIOR | 3/8" MIOR | | Yes | Yes 7/16-20 | | | | | | | | | | | | | | | | | | | | | | | | | | | | | | | | | | | | | | | | | | | | | | | | | | | | | | | | | | |
| Diam. | Height | Sight Glass | Fuse Plug | Sw.Port. | | | | | | | | | | | | | | | | | | | | | | | | | | | | | | | | | | | | | | | | | | | | | | | | | | | | | | | | | | |
| 3.00 | 8.25 | Top | | | | | | | | | | | | | | | | | | | | | | | | | | | | | | | | | | | | | | | | | | | | | | | | | | | | | | | | | | | | |
| Inlet | Outlet | Moist. Ind. | HPRelief | Gauge Port | | | | | | | | | | | | | | | | | | | | | | | | | | | | | | | | | | | | | | | | | | | | | | | | | | | | | | | | | | |
| 3/8" MIOR | 3/8" FOR | | Yes | Yes 7/16-20 | | | | | | | | | | | | | | | | | | | | | | | | | | | | | | | | | | | | | | | | | | | | | | | | | | | | | | | | | | |
| Diam. | Height | Sight Glass | Fuse Plug | Sw.Port. | | | | | | | | | | | | | | | | | | | | | | | | | | | | | | | | | | | | | | | | | | | | | | | | | | | | | | | | | | |
| 3.00 | 10.13 | Top | | | | | | | | | | | | | | | | | | | | | | | | | | | | | | | | | | | | | | | | | | | | | | | | | | | | | | | | | | | | |
| Inlet | Outlet | Moist. Ind. | HPRelief | Gauge Port | | | | | | | | | | | | | | | | | | | | | | | | | | | | | | | | | | | | | | | | | | | | | | | | | | | | | | | | | | |
| 3/8" MIOR | 3/8" FOR | | Yes | M10 | | | | | | | | | | | | | | | | | | | | | | | | | | | | | | | | | | | | | | | | | | | | | | | | | | | | | | | | | | |
| <p>406170 <i>STANDARD</i> 406170A <i>OEM</i></p>  <table border="1"> <thead> <tr> <th>Diam.</th> <th>Height</th> <th>Sight Glass</th> <th>Fuse Plug</th> <th>Sw.Port.</th> </tr> </thead> <tbody> <tr> <td>3.00</td> <td>10.13</td> <td>Side</td> <td></td> <td></td> </tr> <tr> <th>Inlet</th> <th>Outlet</th> <th>Moist. Ind.</th> <th>HPRelief</th> <th>Gauge Port</th> </tr> <tr> <td>3/8" FOR</td> <td>3/8" MIOR</td> <td></td> <td>Yes</td> <td></td> </tr> </tbody> </table> | Diam. | Height | Sight Glass | Fuse Plug | Sw.Port. | 3.00 | 10.13 | Side | | | Inlet | Outlet | Moist. Ind. | HPRelief | Gauge Port | 3/8" FOR | 3/8" MIOR | | Yes | | <p>406171 <i>STANDARD</i> 406171A <i>OEM</i></p>  <table border="1"> <thead> <tr> <th>Diam.</th> <th>Height</th> <th>Sight Glass</th> <th>Fuse Plug</th> <th>Sw.Port.</th> </tr> </thead> <tbody> <tr> <td>3.00</td> <td>10.13</td> <td></td> <td></td> <td></td> </tr> <tr> <th>Inlet</th> <th>Outlet</th> <th>Moist. Ind.</th> <th>HPRelief</th> <th>Gauge Port</th> </tr> <tr> <td>7/16" FOR</td> <td>3/8" FOR</td> <td></td> <td>Yes</td> <td></td> </tr> </tbody> </table> | Diam. | Height | Sight Glass | Fuse Plug | Sw.Port. | 3.00 | 10.13 | | | | Inlet | Outlet | Moist. Ind. | HPRelief | Gauge Port | 7/16" FOR | 3/8" FOR | | Yes | | <p>406172</p>  <table border="1"> <thead> <tr> <th>Diam.</th> <th>Height</th> <th>Sight Glass</th> <th>Fuse Plug</th> <th>Sw.Port.</th> </tr> </thead> <tbody> <tr> <td>3.00</td> <td>10.09</td> <td></td> <td></td> <td></td> </tr> <tr> <th>Inlet</th> <th>Outlet</th> <th>Moist. Ind.</th> <th>HPRelief</th> <th>Gauge Port</th> </tr> <tr> <td>7/16" FOR</td> <td>3/8" FOR</td> <td></td> <td></td> <td></td> </tr> </tbody> </table> | Diam. | Height | Sight Glass | Fuse Plug | Sw.Port. | 3.00 | 10.09 | | | | Inlet | Outlet | Moist. Ind. | HPRelief | Gauge Port | 7/16" FOR | 3/8" FOR | | | |
| Diam. | Height | Sight Glass | Fuse Plug | Sw.Port. | | | | | | | | | | | | | | | | | | | | | | | | | | | | | | | | | | | | | | | | | | | | | | | | | | | | | | | | | | |
| 3.00 | 10.13 | Side | | | | | | | | | | | | | | | | | | | | | | | | | | | | | | | | | | | | | | | | | | | | | | | | | | | | | | | | | | | | |
| Inlet | Outlet | Moist. Ind. | HPRelief | Gauge Port | | | | | | | | | | | | | | | | | | | | | | | | | | | | | | | | | | | | | | | | | | | | | | | | | | | | | | | | | | |
| 3/8" FOR | 3/8" MIOR | | Yes | | | | | | | | | | | | | | | | | | | | | | | | | | | | | | | | | | | | | | | | | | | | | | | | | | | | | | | | | | | |
| Diam. | Height | Sight Glass | Fuse Plug | Sw.Port. | | | | | | | | | | | | | | | | | | | | | | | | | | | | | | | | | | | | | | | | | | | | | | | | | | | | | | | | | | |
| 3.00 | 10.13 | | | | | | | | | | | | | | | | | | | | | | | | | | | | | | | | | | | | | | | | | | | | | | | | | | | | | | | | | | | | | |
| Inlet | Outlet | Moist. Ind. | HPRelief | Gauge Port | | | | | | | | | | | | | | | | | | | | | | | | | | | | | | | | | | | | | | | | | | | | | | | | | | | | | | | | | | |
| 7/16" FOR | 3/8" FOR | | Yes | | | | | | | | | | | | | | | | | | | | | | | | | | | | | | | | | | | | | | | | | | | | | | | | | | | | | | | | | | | |
| Diam. | Height | Sight Glass | Fuse Plug | Sw.Port. | | | | | | | | | | | | | | | | | | | | | | | | | | | | | | | | | | | | | | | | | | | | | | | | | | | | | | | | | | |
| 3.00 | 10.09 | | | | | | | | | | | | | | | | | | | | | | | | | | | | | | | | | | | | | | | | | | | | | | | | | | | | | | | | | | | | | |
| Inlet | Outlet | Moist. Ind. | HPRelief | Gauge Port | | | | | | | | | | | | | | | | | | | | | | | | | | | | | | | | | | | | | | | | | | | | | | | | | | | | | | | | | | |
| 7/16" FOR | 3/8" FOR | | | | | | | | | | | | | | | | | | | | | | | | | | | | | | | | | | | | | | | | | | | | | | | | | | | | | | | | | | | | | |

RECEIVER/DRIERS

PARTS

DRIERS



D712-949

| Diam. | Height | Sight Glass | Fuse Plug | Sw.Port |
|-----------|-----------|-------------|-----------|------------|
| 3.00 | 6.50 | Top | | |
| Inlet | Outlet | Moist. Ind. | HPRelief | Gauge Port |
| 3/8" MIOR | 3/8" MIOR | | Yes | 7/16-20 |



| Diam. | Height | Sight Glass | Fuse Plug | Sw.Port |
|-----------|-----------|-------------|-----------|------------|
| 3.00 | 6.30 | | Yes | |
| Inlet | Outlet | Moist. Ind. | HPRelief | Gauge Port |
| 3/8" MIOR | 3/8" MIOR | | | |



| Diam. | Height | Sight Glass | Fuse Plug | Sw.Port |
|-----------|-----------|-------------|-----------|------------|
| 3.00 | 6.00 | Top | Yes | Yes |
| Inlet | Outlet | Moist. Ind. | HPRelief | Gauge Port |
| 3/8" MIOR | 3/8" MIOR | | Yes | |

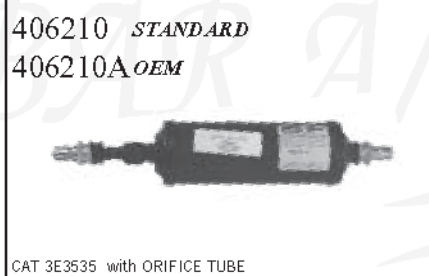

CAT 3E3535 with ORIFICE TUBE

| Diam. | Height | Sight Glass | Fuse Plug | Sw.Port |
|-------------|-------------|-------------|-----------|------------|
| 2.50 | 13.80 | | | |
| Inlet | Outlet | Moist. Ind. | HPRelief | Gauge Port |
| QUICK DISC. | QUICK DISC. | | Yes | |



MAKC 221RD32

| Diam. | Height | Sight Glass | Fuse Plug | Sw.Port |
|-----------|-----------|-------------|-----------|------------|
| 3.00 | 6.30 | | Yes | |
| Inlet | Outlet | Moist. Ind. | HPRelief | Gauge Port |
| 3/8" MIOR | 3/8" MIOR | | Yes | |



JD AT162848

| Diam. | Height | Sight Glass | Fuse Plug | Sw.Port |
|--------------------|--------|-------------|-----------|------------|
| 4.00 | 9.00 | Side | | |
| Inlet | Outlet | Moist. Ind. | HPRelief | Gauge Port |
| 3/8" FOR 3/8" MIOR | | | Yes | |



CAT 106-5534 CAT 5V5859

| Diam. | Height | Sight Glass | Fuse Plug | Sw.Port |
|-----------|-----------|-------------|-----------|------------|
| 4.00 | 7.80 | | | |
| Inlet | Outlet | Moist. Ind. | HPRelief | Gauge Port |
| 3/8" MIOR | 3/8" MIOR | | Yes | Yes |



| Diam. | Height | Sight Glass | Fuse Plug | Sw.Port |
|-----------|-----------|-------------|-----------|------------|
| 4.00 | 7.80 | Top | | Yes |
| Inlet | Outlet | Moist. Ind. | HPRelief | Gauge Port |
| 3/8" MIOR | 3/8" MIOR | | Yes | |



CAT 106-5532

| Diam. | Height | Sight Glass | Fuse Plug | Sw.Port |
|-------------|-------------|-------------|-----------|------------|
| 4.00 | 7.80 | | | Yes |
| Inlet | Outlet | Moist. Ind. | HPRelief | Gauge Port |
| QUICK DISC. | QUICK DISC. | | Yes | |



CAT 106-5533 CAT 9W0549

| Diam. | Height | Sight Glass | Fuse Plug | Sw.Port |
|-------------|-------------|-------------|-----------|------------|
| 4.00 | 7.80 | | | LP |
| Inlet | Outlet | Moist. Ind. | HPRelief | Gauge Port |
| QUICK DISC. | QUICK DISC. | | Yes | Yes |



| Diam. | Height | Sight Glass | Fuse Plug | Sw.Port |
|-----------|-----------|-------------|-----------|------------|
| 4.00 | 7.20 | | Yes | |
| Inlet | Outlet | Moist. Ind. | HPRelief | Gauge Port |
| 3/8" MIOR | 3/8" MIOR | | | |



CAT 906888

| Diam. | Height | Sight Glass | Fuse Plug | Sw.Port |
|-----------|-----------|-------------|-----------|------------|
| 3.00 | 5.90 | Top | Yes | |
| Inlet | Outlet | Moist. Ind. | HPRelief | Gauge Port |
| 3/8" MIOR | 3/8" MIOR | | | |

| <p>406223</p>  <p>IH 118418-C1 IH 118304-C1</p> <table border="1"> <thead> <tr> <th>Diam.</th> <th>Height</th> <th>Sight Glass</th> <th>Fuse Plug</th> <th>Sw.Port.</th> </tr> </thead> <tbody> <tr> <td>4.00</td> <td>6.80</td> <td>Side</td> <td>Yes</td> <td></td> </tr> <tr> <th>Inlet</th> <th>Outlet</th> <th>Moist. Ind.</th> <th>HPRelief</th> <th>Gauge Port.</th> </tr> <tr> <td>3/8" FOR 3/8" MIOR</td> <td></td> <td></td> <td></td> <td></td> </tr> </tbody> </table> | Diam. | Height | Sight Glass | Fuse Plug | Sw.Port. | 4.00 | 6.80 | Side | Yes | | Inlet | Outlet | Moist. Ind. | HPRelief | Gauge Port. | 3/8" FOR 3/8" MIOR | | | | | <p>406224</p>  <p>JD RE49169</p> <table border="1"> <thead> <tr> <th>Diam.</th> <th>Height</th> <th>Sight Glass</th> <th>Fuse Plug</th> <th>Sw.Port.</th> </tr> </thead> <tbody> <tr> <td>4.00</td> <td>7.50</td> <td>2</td> <td></td> <td></td> </tr> <tr> <th>Inlet</th> <th>Outlet</th> <th>Moist. Ind.</th> <th>HPRelief</th> <th>Gauge Port.</th> </tr> <tr> <td>3/8" FOR 3/8" MIOR</td> <td></td> <td></td> <td></td> <td></td> </tr> </tbody> </table> | Diam. | Height | Sight Glass | Fuse Plug | Sw.Port. | 4.00 | 7.50 | 2 | | | Inlet | Outlet | Moist. Ind. | HPRelief | Gauge Port. | 3/8" FOR 3/8" MIOR | | | | | <p>406225 STANDARD 406225A OEM</p>  <p>CAT 6P130 NH 620206 SIGNET 2-17340</p> <table border="1"> <thead> <tr> <th>Diam.</th> <th>Height</th> <th>Sight Glass</th> <th>Fuse Plug</th> <th>Sw.Port.</th> </tr> </thead> <tbody> <tr> <td>4.00</td> <td>7.80</td> <td></td> <td>Yes</td> <td></td> </tr> <tr> <th>Inlet</th> <th>Outlet</th> <th>Moist. Ind.</th> <th>HPRelief</th> <th>Gauge Port.</th> </tr> <tr> <td>3/8" MFL 3/8" MFL</td> <td></td> <td></td> <td></td> <td></td> </tr> </tbody> </table> | Diam. | Height | Sight Glass | Fuse Plug | Sw.Port. | 4.00 | 7.80 | | Yes | | Inlet | Outlet | Moist. Ind. | HPRelief | Gauge Port. | 3/8" MFL 3/8" MFL | | | | |
|--|--------|-------------|-------------|-------------|----------|------|------|------|-----|--|-------|--------|-------------|----------|-------------|---------------------|--|--|--|--|--|-------|--------|-------------|-----------|----------|------|------|-----|-----|-----|-------|--------|-------------|----------|-------------|-----------------------|--|--|-----|-----|--|-------|--------|-------------|-----------|----------|------|------|--|-----|--|-------|--------|-------------|----------|-------------|-------------------------|--|--|--|--|
| Diam. | Height | Sight Glass | Fuse Plug | Sw.Port. | | | | | | | | | | | | | | | | | | | | | | | | | | | | | | | | | | | | | | | | | | | | | | | | | | | | | | | | | | |
| 4.00 | 6.80 | Side | Yes | | | | | | | | | | | | | | | | | | | | | | | | | | | | | | | | | | | | | | | | | | | | | | | | | | | | | | | | | | | |
| Inlet | Outlet | Moist. Ind. | HPRelief | Gauge Port. | | | | | | | | | | | | | | | | | | | | | | | | | | | | | | | | | | | | | | | | | | | | | | | | | | | | | | | | | | |
| 3/8" FOR 3/8" MIOR | | | | | | | | | | | | | | | | | | | | | | | | | | | | | | | | | | | | | | | | | | | | | | | | | | | | | | | | | | | | | | |
| Diam. | Height | Sight Glass | Fuse Plug | Sw.Port. | | | | | | | | | | | | | | | | | | | | | | | | | | | | | | | | | | | | | | | | | | | | | | | | | | | | | | | | | | |
| 4.00 | 7.50 | 2 | | | | | | | | | | | | | | | | | | | | | | | | | | | | | | | | | | | | | | | | | | | | | | | | | | | | | | | | | | | | |
| Inlet | Outlet | Moist. Ind. | HPRelief | Gauge Port. | | | | | | | | | | | | | | | | | | | | | | | | | | | | | | | | | | | | | | | | | | | | | | | | | | | | | | | | | | |
| 3/8" FOR 3/8" MIOR | | | | | | | | | | | | | | | | | | | | | | | | | | | | | | | | | | | | | | | | | | | | | | | | | | | | | | | | | | | | | | |
| Diam. | Height | Sight Glass | Fuse Plug | Sw.Port. | | | | | | | | | | | | | | | | | | | | | | | | | | | | | | | | | | | | | | | | | | | | | | | | | | | | | | | | | | |
| 4.00 | 7.80 | | Yes | | | | | | | | | | | | | | | | | | | | | | | | | | | | | | | | | | | | | | | | | | | | | | | | | | | | | | | | | | | |
| Inlet | Outlet | Moist. Ind. | HPRelief | Gauge Port. | | | | | | | | | | | | | | | | | | | | | | | | | | | | | | | | | | | | | | | | | | | | | | | | | | | | | | | | | | |
| 3/8" MFL 3/8" MFL | | | | | | | | | | | | | | | | | | | | | | | | | | | | | | | | | | | | | | | | | | | | | | | | | | | | | | | | | | | | | | |
| <p>406227 STANDARD 406227A OEM</p>  <table border="1"> <thead> <tr> <th>Diam.</th> <th>Height</th> <th>Sight Glass</th> <th>Fuse Plug</th> <th>Sw.Port.</th> </tr> </thead> <tbody> <tr> <td>2.50</td> <td>9.60</td> <td>Side</td> <td>Yes</td> <td></td> </tr> <tr> <th>Inlet</th> <th>Outlet</th> <th>Moist. Ind.</th> <th>HPRelief</th> <th>Gauge Port.</th> </tr> <tr> <td>3/8" MIOR 3/8" MIOR</td> <td></td> <td></td> <td></td> <td></td> </tr> </tbody> </table> | Diam. | Height | Sight Glass | Fuse Plug | Sw.Port. | 2.50 | 9.60 | Side | Yes | | Inlet | Outlet | Moist. Ind. | HPRelief | Gauge Port. | 3/8" MIOR 3/8" MIOR | | | | | <p>406228 STANDARD 406228A OEM</p>  <table border="1"> <thead> <tr> <th>Diam.</th> <th>Height</th> <th>Sight Glass</th> <th>Fuse Plug</th> <th>Sw.Port.</th> </tr> </thead> <tbody> <tr> <td>3.00</td> <td>6.70</td> <td>Top</td> <td></td> <td>Yes</td> </tr> <tr> <th>Inlet</th> <th>Outlet</th> <th>Moist. Ind.</th> <th>HPRelief</th> <th>Gauge Port.</th> </tr> <tr> <td>3/8" MIOR 3/8" MIOR</td> <td></td> <td></td> <td>Yes</td> <td>Yes</td> </tr> </tbody> </table> | Diam. | Height | Sight Glass | Fuse Plug | Sw.Port. | 3.00 | 6.70 | Top | | Yes | Inlet | Outlet | Moist. Ind. | HPRelief | Gauge Port. | 3/8" MIOR 3/8" MIOR | | | Yes | Yes | <p>406229</p>  <p>PB 18-03841</p> <table border="1"> <thead> <tr> <th>Diam.</th> <th>Height</th> <th>Sight Glass</th> <th>Fuse Plug</th> <th>Sw.Port.</th> </tr> </thead> <tbody> <tr> <td>2.50</td> <td>9.60</td> <td></td> <td></td> <td></td> </tr> <tr> <th>Inlet</th> <th>Outlet</th> <th>Moist. Ind.</th> <th>HPRelief</th> <th>Gauge Port.</th> </tr> <tr> <td>QUICK DISC. QUICK DISC.</td> <td></td> <td></td> <td></td> <td></td> </tr> </tbody> </table> | Diam. | Height | Sight Glass | Fuse Plug | Sw.Port. | 2.50 | 9.60 | | | | Inlet | Outlet | Moist. Ind. | HPRelief | Gauge Port. | QUICK DISC. QUICK DISC. | | | | |
| Diam. | Height | Sight Glass | Fuse Plug | Sw.Port. | | | | | | | | | | | | | | | | | | | | | | | | | | | | | | | | | | | | | | | | | | | | | | | | | | | | | | | | | | |
| 2.50 | 9.60 | Side | Yes | | | | | | | | | | | | | | | | | | | | | | | | | | | | | | | | | | | | | | | | | | | | | | | | | | | | | | | | | | | |
| Inlet | Outlet | Moist. Ind. | HPRelief | Gauge Port. | | | | | | | | | | | | | | | | | | | | | | | | | | | | | | | | | | | | | | | | | | | | | | | | | | | | | | | | | | |
| 3/8" MIOR 3/8" MIOR | | | | | | | | | | | | | | | | | | | | | | | | | | | | | | | | | | | | | | | | | | | | | | | | | | | | | | | | | | | | | | |
| Diam. | Height | Sight Glass | Fuse Plug | Sw.Port. | | | | | | | | | | | | | | | | | | | | | | | | | | | | | | | | | | | | | | | | | | | | | | | | | | | | | | | | | | |
| 3.00 | 6.70 | Top | | Yes | | | | | | | | | | | | | | | | | | | | | | | | | | | | | | | | | | | | | | | | | | | | | | | | | | | | | | | | | | |
| Inlet | Outlet | Moist. Ind. | HPRelief | Gauge Port. | | | | | | | | | | | | | | | | | | | | | | | | | | | | | | | | | | | | | | | | | | | | | | | | | | | | | | | | | | |
| 3/8" MIOR 3/8" MIOR | | | Yes | Yes | | | | | | | | | | | | | | | | | | | | | | | | | | | | | | | | | | | | | | | | | | | | | | | | | | | | | | | | | | |
| Diam. | Height | Sight Glass | Fuse Plug | Sw.Port. | | | | | | | | | | | | | | | | | | | | | | | | | | | | | | | | | | | | | | | | | | | | | | | | | | | | | | | | | | |
| 2.50 | 9.60 | | | | | | | | | | | | | | | | | | | | | | | | | | | | | | | | | | | | | | | | | | | | | | | | | | | | | | | | | | | | | |
| Inlet | Outlet | Moist. Ind. | HPRelief | Gauge Port. | | | | | | | | | | | | | | | | | | | | | | | | | | | | | | | | | | | | | | | | | | | | | | | | | | | | | | | | | | |
| QUICK DISC. QUICK DISC. | | | | | | | | | | | | | | | | | | | | | | | | | | | | | | | | | | | | | | | | | | | | | | | | | | | | | | | | | | | | | | |
| <p>406276 STANDARD 406276A OEM</p>  <p>CASE 1990758C2</p> <table border="1"> <thead> <tr> <th>Diam.</th> <th>Height</th> <th>Sight Glass</th> <th>Fuse Plug</th> <th>Sw.Port.</th> </tr> </thead> <tbody> <tr> <td>4.00</td> <td>7.77</td> <td></td> <td></td> <td></td> </tr> <tr> <th>Inlet</th> <th>Outlet</th> <th>Moist. Ind.</th> <th>HPRelief</th> <th>Gauge Port.</th> </tr> <tr> <td>3/8" FOR 3/8" MIOR</td> <td></td> <td></td> <td></td> <td></td> </tr> </tbody> </table> | Diam. | Height | Sight Glass | Fuse Plug | Sw.Port. | 4.00 | 7.77 | | | | Inlet | Outlet | Moist. Ind. | HPRelief | Gauge Port. | 3/8" FOR 3/8" MIOR | | | | | <p>406279 STANDARD 406279A OEM</p>  <table border="1"> <thead> <tr> <th>Diam.</th> <th>Height</th> <th>Sight Glass</th> <th>Fuse Plug</th> <th>Sw.Port.</th> </tr> </thead> <tbody> <tr> <td>4.00</td> <td>8.00</td> <td></td> <td></td> <td></td> </tr> <tr> <th>Inlet</th> <th>Outlet</th> <th>Moist. Ind.</th> <th>HPRelief</th> <th>Gauge Port.</th> </tr> <tr> <td>3/8" FOR 3/8" MIOR</td> <td></td> <td></td> <td></td> <td></td> </tr> </tbody> </table> | Diam. | Height | Sight Glass | Fuse Plug | Sw.Port. | 4.00 | 8.00 | | | | Inlet | Outlet | Moist. Ind. | HPRelief | Gauge Port. | 3/8" FOR 3/8" MIOR | | | | | <p>406378</p>  <p>KOMATSU#20Y-979-3120</p> <table border="1"> <thead> <tr> <th>Diam.</th> <th>Height</th> <th>Sight Glass</th> <th>Fuse Plug</th> <th>Sw.Port.</th> </tr> </thead> <tbody> <tr> <td>2.50</td> <td>9.30</td> <td></td> <td></td> <td></td> </tr> <tr> <th>Inlet</th> <th>Outlet</th> <th>Moist. Ind.</th> <th>HPRelief</th> <th>Gauge Port.</th> </tr> <tr> <td>PAD-DENSO PAD-DENSO</td> <td></td> <td></td> <td></td> <td></td> </tr> </tbody> </table> | Diam. | Height | Sight Glass | Fuse Plug | Sw.Port. | 2.50 | 9.30 | | | | Inlet | Outlet | Moist. Ind. | HPRelief | Gauge Port. | PAD-DENSO PAD-DENSO | | | | |
| Diam. | Height | Sight Glass | Fuse Plug | Sw.Port. | | | | | | | | | | | | | | | | | | | | | | | | | | | | | | | | | | | | | | | | | | | | | | | | | | | | | | | | | | |
| 4.00 | 7.77 | | | | | | | | | | | | | | | | | | | | | | | | | | | | | | | | | | | | | | | | | | | | | | | | | | | | | | | | | | | | | |
| Inlet | Outlet | Moist. Ind. | HPRelief | Gauge Port. | | | | | | | | | | | | | | | | | | | | | | | | | | | | | | | | | | | | | | | | | | | | | | | | | | | | | | | | | | |
| 3/8" FOR 3/8" MIOR | | | | | | | | | | | | | | | | | | | | | | | | | | | | | | | | | | | | | | | | | | | | | | | | | | | | | | | | | | | | | | |
| Diam. | Height | Sight Glass | Fuse Plug | Sw.Port. | | | | | | | | | | | | | | | | | | | | | | | | | | | | | | | | | | | | | | | | | | | | | | | | | | | | | | | | | | |
| 4.00 | 8.00 | | | | | | | | | | | | | | | | | | | | | | | | | | | | | | | | | | | | | | | | | | | | | | | | | | | | | | | | | | | | | |
| Inlet | Outlet | Moist. Ind. | HPRelief | Gauge Port. | | | | | | | | | | | | | | | | | | | | | | | | | | | | | | | | | | | | | | | | | | | | | | | | | | | | | | | | | | |
| 3/8" FOR 3/8" MIOR | | | | | | | | | | | | | | | | | | | | | | | | | | | | | | | | | | | | | | | | | | | | | | | | | | | | | | | | | | | | | | |
| Diam. | Height | Sight Glass | Fuse Plug | Sw.Port. | | | | | | | | | | | | | | | | | | | | | | | | | | | | | | | | | | | | | | | | | | | | | | | | | | | | | | | | | | |
| 2.50 | 9.30 | | | | | | | | | | | | | | | | | | | | | | | | | | | | | | | | | | | | | | | | | | | | | | | | | | | | | | | | | | | | | |
| Inlet | Outlet | Moist. Ind. | HPRelief | Gauge Port. | | | | | | | | | | | | | | | | | | | | | | | | | | | | | | | | | | | | | | | | | | | | | | | | | | | | | | | | | | |
| PAD-DENSO PAD-DENSO | | | | | | | | | | | | | | | | | | | | | | | | | | | | | | | | | | | | | | | | | | | | | | | | | | | | | | | | | | | | | | |
| <p>406547</p>  <table border="1"> <thead> <tr> <th>Diam.</th> <th>Height</th> <th>Sight Glass</th> <th>Fuse Plug</th> <th>Sw.Port.</th> </tr> </thead> <tbody> <tr> <td>4.00</td> <td>7.20</td> <td></td> <td></td> <td></td> </tr> <tr> <th>Inlet</th> <th>Outlet</th> <th>Moist. Ind.</th> <th>HPRelief</th> <th>Gauge Port.</th> </tr> <tr> <td>3/8" MIOR 3/8" MIOR</td> <td></td> <td></td> <td></td> <td></td> </tr> </tbody> </table> | Diam. | Height | Sight Glass | Fuse Plug | Sw.Port. | 4.00 | 7.20 | | | | Inlet | Outlet | Moist. Ind. | HPRelief | Gauge Port. | 3/8" MIOR 3/8" MIOR | | | | | <p>407000</p>  <table border="1"> <thead> <tr> <th>Diam.</th> <th>Height</th> <th>Sight Glass</th> <th>Fuse Plug</th> <th>Sw.Port.</th> </tr> </thead> <tbody> <tr> <td>2.50</td> <td>8.00</td> <td>Yes</td> <td>Yes</td> <td></td> </tr> <tr> <th>Inlet</th> <th>Outlet</th> <th>Moist. Ind.</th> <th>HPRelief</th> <th>Gauge Port.</th> </tr> <tr> <td>5/16" Barb 5/16" Barb</td> <td></td> <td></td> <td></td> <td></td> </tr> </tbody> </table> | Diam. | Height | Sight Glass | Fuse Plug | Sw.Port. | 2.50 | 8.00 | Yes | Yes | | Inlet | Outlet | Moist. Ind. | HPRelief | Gauge Port. | 5/16" Barb 5/16" Barb | | | | | <p>407001</p>  <table border="1"> <thead> <tr> <th>Diam.</th> <th>Height</th> <th>Sight Glass</th> <th>Fuse Plug</th> <th>Sw.Port.</th> </tr> </thead> <tbody> <tr> <td>2.50</td> <td>6.75</td> <td></td> <td>Yes</td> <td></td> </tr> <tr> <th>Inlet</th> <th>Outlet</th> <th>Moist. Ind.</th> <th>HPRelief</th> <th>Gauge Port.</th> </tr> <tr> <td>3/8" MFL 3/8" MFL</td> <td></td> <td></td> <td></td> <td></td> </tr> </tbody> </table> | Diam. | Height | Sight Glass | Fuse Plug | Sw.Port. | 2.50 | 6.75 | | Yes | | Inlet | Outlet | Moist. Ind. | HPRelief | Gauge Port. | 3/8" MFL 3/8" MFL | | | | |
| Diam. | Height | Sight Glass | Fuse Plug | Sw.Port. | | | | | | | | | | | | | | | | | | | | | | | | | | | | | | | | | | | | | | | | | | | | | | | | | | | | | | | | | | |
| 4.00 | 7.20 | | | | | | | | | | | | | | | | | | | | | | | | | | | | | | | | | | | | | | | | | | | | | | | | | | | | | | | | | | | | | |
| Inlet | Outlet | Moist. Ind. | HPRelief | Gauge Port. | | | | | | | | | | | | | | | | | | | | | | | | | | | | | | | | | | | | | | | | | | | | | | | | | | | | | | | | | | |
| 3/8" MIOR 3/8" MIOR | | | | | | | | | | | | | | | | | | | | | | | | | | | | | | | | | | | | | | | | | | | | | | | | | | | | | | | | | | | | | | |
| Diam. | Height | Sight Glass | Fuse Plug | Sw.Port. | | | | | | | | | | | | | | | | | | | | | | | | | | | | | | | | | | | | | | | | | | | | | | | | | | | | | | | | | | |
| 2.50 | 8.00 | Yes | Yes | | | | | | | | | | | | | | | | | | | | | | | | | | | | | | | | | | | | | | | | | | | | | | | | | | | | | | | | | | | |
| Inlet | Outlet | Moist. Ind. | HPRelief | Gauge Port. | | | | | | | | | | | | | | | | | | | | | | | | | | | | | | | | | | | | | | | | | | | | | | | | | | | | | | | | | | |
| 5/16" Barb 5/16" Barb | | | | | | | | | | | | | | | | | | | | | | | | | | | | | | | | | | | | | | | | | | | | | | | | | | | | | | | | | | | | | | |
| Diam. | Height | Sight Glass | Fuse Plug | Sw.Port. | | | | | | | | | | | | | | | | | | | | | | | | | | | | | | | | | | | | | | | | | | | | | | | | | | | | | | | | | | |
| 2.50 | 6.75 | | Yes | | | | | | | | | | | | | | | | | | | | | | | | | | | | | | | | | | | | | | | | | | | | | | | | | | | | | | | | | | | |
| Inlet | Outlet | Moist. Ind. | HPRelief | Gauge Port. | | | | | | | | | | | | | | | | | | | | | | | | | | | | | | | | | | | | | | | | | | | | | | | | | | | | | | | | | | |
| 3/8" MFL 3/8" MFL | | | | | | | | | | | | | | | | | | | | | | | | | | | | | | | | | | | | | | | | | | | | | | | | | | | | | | | | | | | | | | |

RECEIVER/DRIERS

PARTS

DRIERS

| <p>407002</p>  <table border="1"> <thead> <tr> <th>Diam.</th> <th>Height</th> <th>Sight Glass</th> <th>Fuse Plug</th> <th>Sw.Port.</th> </tr> </thead> <tbody> <tr> <td>2.50</td> <td>8.00</td> <td></td> <td>Yes</td> <td></td> </tr> <tr> <th>Inlet</th> <th>Outlet</th> <th>Moist. Ind.</th> <th>HPRelief</th> <th>Gauge Port.</th> </tr> <tr> <td>3/8" MFL</td> <td>3/8" MFL</td> <td></td> <td></td> <td></td> </tr> </tbody> </table> | Diam. | Height | Sight Glass | Fuse Plug | Sw.Port. | 2.50 | 8.00 | | Yes | | Inlet | Outlet | Moist. Ind. | HPRelief | Gauge Port. | 3/8" MFL | 3/8" MFL | | | | <p>407003 <i>STANDARD</i> 407003A <i>OEM</i></p>  <table border="1"> <thead> <tr> <th>Diam.</th> <th>Height</th> <th>Sight Glass</th> <th>Fuse Plug</th> <th>Sw.Port.</th> </tr> </thead> <tbody> <tr> <td>2.50</td> <td>6.63</td> <td></td> <td></td> <td></td> </tr> <tr> <th>Inlet</th> <th>Outlet</th> <th>Moist. Ind.</th> <th>HPRelief</th> <th>Gauge Port.</th> </tr> <tr> <td>3/8" MIOR</td> <td>1/2" MIOR</td> <td></td> <td></td> <td></td> </tr> </tbody> </table> | Diam. | Height | Sight Glass | Fuse Plug | Sw.Port. | 2.50 | 6.63 | | | | Inlet | Outlet | Moist. Ind. | HPRelief | Gauge Port. | 3/8" MIOR | 1/2" MIOR | | | | <p>407004</p>  <table border="1"> <thead> <tr> <th>Diam.</th> <th>Height</th> <th>Sight Glass</th> <th>Fuse Plug</th> <th>Sw.Port.</th> </tr> </thead> <tbody> <tr> <td>2.50</td> <td>10.75</td> <td></td> <td>Yes</td> <td></td> </tr> <tr> <th>Inlet</th> <th>Outlet</th> <th>Moist. Ind.</th> <th>HPRelief</th> <th>Gauge Port.</th> </tr> <tr> <td>QUICK DISC.</td> <td>QUICK DISC.</td> <td></td> <td></td> <td>Yes</td> </tr> </tbody> </table> | Diam. | Height | Sight Glass | Fuse Plug | Sw.Port. | 2.50 | 10.75 | | Yes | | Inlet | Outlet | Moist. Ind. | HPRelief | Gauge Port. | QUICK DISC. | QUICK DISC. | | | Yes |
|---|-------------|-------------|-------------|-------------|----------|------|-------|-----|-----|--|-------|--------|-------------|----------|-------------|-------------|-------------|--|-----|-----|--|-------|--------|-------------|-----------|----------|------|-------|-----|-----|--|-------|--------|-------------|----------|-------------|-----------|-----------|--|-----|-----|--|-------|--------|-------------|-----------|----------|------|-------|--|-----|--|-------|--------|-------------|----------|-------------|-------------|-------------|--|--|-----|
| Diam. | Height | Sight Glass | Fuse Plug | Sw.Port. | | | | | | | | | | | | | | | | | | | | | | | | | | | | | | | | | | | | | | | | | | | | | | | | | | | | | | | | | | |
| 2.50 | 8.00 | | Yes | | | | | | | | | | | | | | | | | | | | | | | | | | | | | | | | | | | | | | | | | | | | | | | | | | | | | | | | | | | |
| Inlet | Outlet | Moist. Ind. | HPRelief | Gauge Port. | | | | | | | | | | | | | | | | | | | | | | | | | | | | | | | | | | | | | | | | | | | | | | | | | | | | | | | | | | |
| 3/8" MFL | 3/8" MFL | | | | | | | | | | | | | | | | | | | | | | | | | | | | | | | | | | | | | | | | | | | | | | | | | | | | | | | | | | | | | |
| Diam. | Height | Sight Glass | Fuse Plug | Sw.Port. | | | | | | | | | | | | | | | | | | | | | | | | | | | | | | | | | | | | | | | | | | | | | | | | | | | | | | | | | | |
| 2.50 | 6.63 | | | | | | | | | | | | | | | | | | | | | | | | | | | | | | | | | | | | | | | | | | | | | | | | | | | | | | | | | | | | | |
| Inlet | Outlet | Moist. Ind. | HPRelief | Gauge Port. | | | | | | | | | | | | | | | | | | | | | | | | | | | | | | | | | | | | | | | | | | | | | | | | | | | | | | | | | | |
| 3/8" MIOR | 1/2" MIOR | | | | | | | | | | | | | | | | | | | | | | | | | | | | | | | | | | | | | | | | | | | | | | | | | | | | | | | | | | | | | |
| Diam. | Height | Sight Glass | Fuse Plug | Sw.Port. | | | | | | | | | | | | | | | | | | | | | | | | | | | | | | | | | | | | | | | | | | | | | | | | | | | | | | | | | | |
| 2.50 | 10.75 | | Yes | | | | | | | | | | | | | | | | | | | | | | | | | | | | | | | | | | | | | | | | | | | | | | | | | | | | | | | | | | | |
| Inlet | Outlet | Moist. Ind. | HPRelief | Gauge Port. | | | | | | | | | | | | | | | | | | | | | | | | | | | | | | | | | | | | | | | | | | | | | | | | | | | | | | | | | | |
| QUICK DISC. | QUICK DISC. | | | Yes | | | | | | | | | | | | | | | | | | | | | | | | | | | | | | | | | | | | | | | | | | | | | | | | | | | | | | | | | | |
| <p>407005</p>  <table border="1"> <thead> <tr> <th>Diam.</th> <th>Height</th> <th>Sight Glass</th> <th>Fuse Plug</th> <th>Sw.Port.</th> </tr> </thead> <tbody> <tr> <td>2.50</td> <td>8.00</td> <td></td> <td>Yes</td> <td></td> </tr> <tr> <th>Inlet</th> <th>Outlet</th> <th>Moist. Ind.</th> <th>HPRelief</th> <th>Gauge Port.</th> </tr> <tr> <td>3/8" MIOR</td> <td>3/8" MIOR</td> <td></td> <td></td> <td></td> </tr> </tbody> </table> | Diam. | Height | Sight Glass | Fuse Plug | Sw.Port. | 2.50 | 8.00 | | Yes | | Inlet | Outlet | Moist. Ind. | HPRelief | Gauge Port. | 3/8" MIOR | 3/8" MIOR | | | | <p>407006</p>  <table border="1"> <thead> <tr> <th>Diam.</th> <th>Height</th> <th>Sight Glass</th> <th>Fuse Plug</th> <th>Sw.Port.</th> </tr> </thead> <tbody> <tr> <td>2.50</td> <td>6.00</td> <td></td> <td>Yes</td> <td></td> </tr> <tr> <th>Inlet</th> <th>Outlet</th> <th>Moist. Ind.</th> <th>HPRelief</th> <th>Gauge Port.</th> </tr> <tr> <td>3/8" MFL</td> <td>3/8" MFL</td> <td></td> <td></td> <td></td> </tr> </tbody> </table> | Diam. | Height | Sight Glass | Fuse Plug | Sw.Port. | 2.50 | 6.00 | | Yes | | Inlet | Outlet | Moist. Ind. | HPRelief | Gauge Port. | 3/8" MFL | 3/8" MFL | | | | <p>407007</p>  <table border="1"> <thead> <tr> <th>Diam.</th> <th>Height</th> <th>Sight Glass</th> <th>Fuse Plug</th> <th>Sw.Port.</th> </tr> </thead> <tbody> <tr> <td>2.50</td> <td>8.00</td> <td></td> <td></td> <td></td> </tr> <tr> <th>Inlet</th> <th>Outlet</th> <th>Moist. Ind.</th> <th>HPRelief</th> <th>Gauge Port.</th> </tr> <tr> <td>5/16" Barb</td> <td>5/16" Barb</td> <td></td> <td></td> <td></td> </tr> </tbody> </table> | Diam. | Height | Sight Glass | Fuse Plug | Sw.Port. | 2.50 | 8.00 | | | | Inlet | Outlet | Moist. Ind. | HPRelief | Gauge Port. | 5/16" Barb | 5/16" Barb | | | |
| Diam. | Height | Sight Glass | Fuse Plug | Sw.Port. | | | | | | | | | | | | | | | | | | | | | | | | | | | | | | | | | | | | | | | | | | | | | | | | | | | | | | | | | | |
| 2.50 | 8.00 | | Yes | | | | | | | | | | | | | | | | | | | | | | | | | | | | | | | | | | | | | | | | | | | | | | | | | | | | | | | | | | | |
| Inlet | Outlet | Moist. Ind. | HPRelief | Gauge Port. | | | | | | | | | | | | | | | | | | | | | | | | | | | | | | | | | | | | | | | | | | | | | | | | | | | | | | | | | | |
| 3/8" MIOR | 3/8" MIOR | | | | | | | | | | | | | | | | | | | | | | | | | | | | | | | | | | | | | | | | | | | | | | | | | | | | | | | | | | | | | |
| Diam. | Height | Sight Glass | Fuse Plug | Sw.Port. | | | | | | | | | | | | | | | | | | | | | | | | | | | | | | | | | | | | | | | | | | | | | | | | | | | | | | | | | | |
| 2.50 | 6.00 | | Yes | | | | | | | | | | | | | | | | | | | | | | | | | | | | | | | | | | | | | | | | | | | | | | | | | | | | | | | | | | | |
| Inlet | Outlet | Moist. Ind. | HPRelief | Gauge Port. | | | | | | | | | | | | | | | | | | | | | | | | | | | | | | | | | | | | | | | | | | | | | | | | | | | | | | | | | | |
| 3/8" MFL | 3/8" MFL | | | | | | | | | | | | | | | | | | | | | | | | | | | | | | | | | | | | | | | | | | | | | | | | | | | | | | | | | | | | | |
| Diam. | Height | Sight Glass | Fuse Plug | Sw.Port. | | | | | | | | | | | | | | | | | | | | | | | | | | | | | | | | | | | | | | | | | | | | | | | | | | | | | | | | | | |
| 2.50 | 8.00 | | | | | | | | | | | | | | | | | | | | | | | | | | | | | | | | | | | | | | | | | | | | | | | | | | | | | | | | | | | | | |
| Inlet | Outlet | Moist. Ind. | HPRelief | Gauge Port. | | | | | | | | | | | | | | | | | | | | | | | | | | | | | | | | | | | | | | | | | | | | | | | | | | | | | | | | | | |
| 5/16" Barb | 5/16" Barb | | | | | | | | | | | | | | | | | | | | | | | | | | | | | | | | | | | | | | | | | | | | | | | | | | | | | | | | | | | | | |
| <p>407008</p>  <table border="1"> <thead> <tr> <th>Diam.</th> <th>Height</th> <th>Sight Glass</th> <th>Fuse Plug</th> <th>Sw.Port.</th> </tr> </thead> <tbody> <tr> <td>2.50</td> <td>9.63</td> <td></td> <td></td> <td></td> </tr> <tr> <th>Inlet</th> <th>Outlet</th> <th>Moist. Ind.</th> <th>HPRelief</th> <th>Gauge Port.</th> </tr> <tr> <td>QUICK DISC.</td> <td>QUICK DISC.</td> <td></td> <td></td> <td></td> </tr> </tbody> </table> | Diam. | Height | Sight Glass | Fuse Plug | Sw.Port. | 2.50 | 9.63 | | | | Inlet | Outlet | Moist. Ind. | HPRelief | Gauge Port. | QUICK DISC. | QUICK DISC. | | | | <p>407009</p>  <table border="1"> <thead> <tr> <th>Diam.</th> <th>Height</th> <th>Sight Glass</th> <th>Fuse Plug</th> <th>Sw.Port.</th> </tr> </thead> <tbody> <tr> <td>3.00</td> <td>6.31</td> <td></td> <td>Yes</td> <td></td> </tr> <tr> <th>Inlet</th> <th>Outlet</th> <th>Moist. Ind.</th> <th>HPRelief</th> <th>Gauge Port.</th> </tr> <tr> <td>3/8" MIOR</td> <td>3/8" MIOR</td> <td></td> <td></td> <td></td> </tr> </tbody> </table> | Diam. | Height | Sight Glass | Fuse Plug | Sw.Port. | 3.00 | 6.31 | | Yes | | Inlet | Outlet | Moist. Ind. | HPRelief | Gauge Port. | 3/8" MIOR | 3/8" MIOR | | | | <p>407010</p>  <table border="1"> <thead> <tr> <th>Diam.</th> <th>Height</th> <th>Sight Glass</th> <th>Fuse Plug</th> <th>Sw.Port.</th> </tr> </thead> <tbody> <tr> <td>3.00</td> <td>10.13</td> <td></td> <td></td> <td></td> </tr> <tr> <th>Inlet</th> <th>Outlet</th> <th>Moist. Ind.</th> <th>HPRelief</th> <th>Gauge Port.</th> </tr> <tr> <td>3/8" MIOR</td> <td>3/8" MIOR</td> <td></td> <td></td> <td></td> </tr> </tbody> </table> | Diam. | Height | Sight Glass | Fuse Plug | Sw.Port. | 3.00 | 10.13 | | | | Inlet | Outlet | Moist. Ind. | HPRelief | Gauge Port. | 3/8" MIOR | 3/8" MIOR | | | |
| Diam. | Height | Sight Glass | Fuse Plug | Sw.Port. | | | | | | | | | | | | | | | | | | | | | | | | | | | | | | | | | | | | | | | | | | | | | | | | | | | | | | | | | | |
| 2.50 | 9.63 | | | | | | | | | | | | | | | | | | | | | | | | | | | | | | | | | | | | | | | | | | | | | | | | | | | | | | | | | | | | | |
| Inlet | Outlet | Moist. Ind. | HPRelief | Gauge Port. | | | | | | | | | | | | | | | | | | | | | | | | | | | | | | | | | | | | | | | | | | | | | | | | | | | | | | | | | | |
| QUICK DISC. | QUICK DISC. | | | | | | | | | | | | | | | | | | | | | | | | | | | | | | | | | | | | | | | | | | | | | | | | | | | | | | | | | | | | | |
| Diam. | Height | Sight Glass | Fuse Plug | Sw.Port. | | | | | | | | | | | | | | | | | | | | | | | | | | | | | | | | | | | | | | | | | | | | | | | | | | | | | | | | | | |
| 3.00 | 6.31 | | Yes | | | | | | | | | | | | | | | | | | | | | | | | | | | | | | | | | | | | | | | | | | | | | | | | | | | | | | | | | | | |
| Inlet | Outlet | Moist. Ind. | HPRelief | Gauge Port. | | | | | | | | | | | | | | | | | | | | | | | | | | | | | | | | | | | | | | | | | | | | | | | | | | | | | | | | | | |
| 3/8" MIOR | 3/8" MIOR | | | | | | | | | | | | | | | | | | | | | | | | | | | | | | | | | | | | | | | | | | | | | | | | | | | | | | | | | | | | | |
| Diam. | Height | Sight Glass | Fuse Plug | Sw.Port. | | | | | | | | | | | | | | | | | | | | | | | | | | | | | | | | | | | | | | | | | | | | | | | | | | | | | | | | | | |
| 3.00 | 10.13 | | | | | | | | | | | | | | | | | | | | | | | | | | | | | | | | | | | | | | | | | | | | | | | | | | | | | | | | | | | | | |
| Inlet | Outlet | Moist. Ind. | HPRelief | Gauge Port. | | | | | | | | | | | | | | | | | | | | | | | | | | | | | | | | | | | | | | | | | | | | | | | | | | | | | | | | | | |
| 3/8" MIOR | 3/8" MIOR | | | | | | | | | | | | | | | | | | | | | | | | | | | | | | | | | | | | | | | | | | | | | | | | | | | | | | | | | | | | | |
| <p>407011</p>  <table border="1"> <thead> <tr> <th>Diam.</th> <th>Height</th> <th>Sight Glass</th> <th>Fuse Plug</th> <th>Sw.Port.</th> </tr> </thead> <tbody> <tr> <td>3.00</td> <td>10.13</td> <td>Yes</td> <td></td> <td></td> </tr> <tr> <th>Inlet</th> <th>Outlet</th> <th>Moist. Ind.</th> <th>HPRelief</th> <th>Gauge Port.</th> </tr> <tr> <td>3/8" MIOR</td> <td>3/8" MIOR</td> <td></td> <td>Yes</td> <td>Yes</td> </tr> </tbody> </table> | Diam. | Height | Sight Glass | Fuse Plug | Sw.Port. | 3.00 | 10.13 | Yes | | | Inlet | Outlet | Moist. Ind. | HPRelief | Gauge Port. | 3/8" MIOR | 3/8" MIOR | | Yes | Yes | <p>407012</p>  <table border="1"> <thead> <tr> <th>Diam.</th> <th>Height</th> <th>Sight Glass</th> <th>Fuse Plug</th> <th>Sw.Port.</th> </tr> </thead> <tbody> <tr> <td>3.00</td> <td>10.13</td> <td>Yes</td> <td></td> <td></td> </tr> <tr> <th>Inlet</th> <th>Outlet</th> <th>Moist. Ind.</th> <th>HPRelief</th> <th>Gauge Port.</th> </tr> <tr> <td>3/8" MIOR</td> <td>3/8" MIOR</td> <td></td> <td>Yes</td> <td>Yes</td> </tr> </tbody> </table> | Diam. | Height | Sight Glass | Fuse Plug | Sw.Port. | 3.00 | 10.13 | Yes | | | Inlet | Outlet | Moist. Ind. | HPRelief | Gauge Port. | 3/8" MIOR | 3/8" MIOR | | Yes | Yes | <p>407013</p>  <table border="1"> <thead> <tr> <th>Diam.</th> <th>Height</th> <th>Sight Glass</th> <th>Fuse Plug</th> <th>Sw.Port.</th> </tr> </thead> <tbody> <tr> <td>3.00</td> <td>8.25</td> <td></td> <td></td> <td></td> </tr> <tr> <th>Inlet</th> <th>Outlet</th> <th>Moist. Ind.</th> <th>HPRelief</th> <th>Gauge Port.</th> </tr> <tr> <td>3/8" MIOR</td> <td>3/8" MIOR</td> <td></td> <td></td> <td>Yes</td> </tr> </tbody> </table> | Diam. | Height | Sight Glass | Fuse Plug | Sw.Port. | 3.00 | 8.25 | | | | Inlet | Outlet | Moist. Ind. | HPRelief | Gauge Port. | 3/8" MIOR | 3/8" MIOR | | | Yes |
| Diam. | Height | Sight Glass | Fuse Plug | Sw.Port. | | | | | | | | | | | | | | | | | | | | | | | | | | | | | | | | | | | | | | | | | | | | | | | | | | | | | | | | | | |
| 3.00 | 10.13 | Yes | | | | | | | | | | | | | | | | | | | | | | | | | | | | | | | | | | | | | | | | | | | | | | | | | | | | | | | | | | | | |
| Inlet | Outlet | Moist. Ind. | HPRelief | Gauge Port. | | | | | | | | | | | | | | | | | | | | | | | | | | | | | | | | | | | | | | | | | | | | | | | | | | | | | | | | | | |
| 3/8" MIOR | 3/8" MIOR | | Yes | Yes | | | | | | | | | | | | | | | | | | | | | | | | | | | | | | | | | | | | | | | | | | | | | | | | | | | | | | | | | | |
| Diam. | Height | Sight Glass | Fuse Plug | Sw.Port. | | | | | | | | | | | | | | | | | | | | | | | | | | | | | | | | | | | | | | | | | | | | | | | | | | | | | | | | | | |
| 3.00 | 10.13 | Yes | | | | | | | | | | | | | | | | | | | | | | | | | | | | | | | | | | | | | | | | | | | | | | | | | | | | | | | | | | | | |
| Inlet | Outlet | Moist. Ind. | HPRelief | Gauge Port. | | | | | | | | | | | | | | | | | | | | | | | | | | | | | | | | | | | | | | | | | | | | | | | | | | | | | | | | | | |
| 3/8" MIOR | 3/8" MIOR | | Yes | Yes | | | | | | | | | | | | | | | | | | | | | | | | | | | | | | | | | | | | | | | | | | | | | | | | | | | | | | | | | | |
| Diam. | Height | Sight Glass | Fuse Plug | Sw.Port. | | | | | | | | | | | | | | | | | | | | | | | | | | | | | | | | | | | | | | | | | | | | | | | | | | | | | | | | | | |
| 3.00 | 8.25 | | | | | | | | | | | | | | | | | | | | | | | | | | | | | | | | | | | | | | | | | | | | | | | | | | | | | | | | | | | | | |
| Inlet | Outlet | Moist. Ind. | HPRelief | Gauge Port. | | | | | | | | | | | | | | | | | | | | | | | | | | | | | | | | | | | | | | | | | | | | | | | | | | | | | | | | | | |
| 3/8" MIOR | 3/8" MIOR | | | Yes | | | | | | | | | | | | | | | | | | | | | | | | | | | | | | | | | | | | | | | | | | | | | | | | | | | | | | | | | | |

| <p>407014</p>  <table border="1"> <thead> <tr> <th>Diam.</th> <th>Height</th> <th>Sight Glass</th> <th>Fuse Plug</th> <th>Sw.Port.</th> </tr> </thead> <tbody> <tr> <td>3.00</td> <td>9.19</td> <td></td> <td></td> <td>Yes</td> </tr> <tr> <th>Inlet</th> <th>Outlet</th> <th>Moist. Ind.</th> <th>HPRelief</th> <th>Gauge Port.</th> </tr> <tr> <td>3/8" MIOR</td> <td>3/8" MIOR</td> <td></td> <td>Yes</td> <td>Yes</td> </tr> </tbody> </table> | Diam. | Height | Sight Glass | Fuse Plug | Sw.Port. | 3.00 | 9.19 | | | Yes | Inlet | Outlet | Moist. Ind. | HPRelief | Gauge Port. | 3/8" MIOR | 3/8" MIOR | | Yes | Yes | <p>407015</p>  <table border="1"> <thead> <tr> <th>Diam.</th> <th>Height</th> <th>Sight Glass</th> <th>Fuse Plug</th> <th>Sw.Port.</th> </tr> </thead> <tbody> <tr> <td>3.00</td> <td>8.25</td> <td></td> <td></td> <td></td> </tr> <tr> <th>Inlet</th> <th>Outlet</th> <th>Moist. Ind.</th> <th>HPRelief</th> <th>Gauge Port.</th> </tr> <tr> <td>3/8" MIOR</td> <td>3/8" FOR</td> <td></td> <td>Yes</td> <td>Yes</td> </tr> </tbody> </table> | Diam. | Height | Sight Glass | Fuse Plug | Sw.Port. | 3.00 | 8.25 | | | | Inlet | Outlet | Moist. Ind. | HPRelief | Gauge Port. | 3/8" MIOR | 3/8" FOR | | Yes | Yes | <p>407016</p>  <table border="1"> <thead> <tr> <th>Diam.</th> <th>Height</th> <th>Sight Glass</th> <th>Fuse Plug</th> <th>Sw.Port.</th> </tr> </thead> <tbody> <tr> <td>3.00</td> <td>10.13</td> <td></td> <td></td> <td></td> </tr> <tr> <th>Inlet</th> <th>Outlet</th> <th>Moist. Ind.</th> <th>HPRelief</th> <th>Gauge Port.</th> </tr> <tr> <td>3/8" MIOR</td> <td>3/8" FOR</td> <td></td> <td>Yes</td> <td>Yes</td> </tr> </tbody> </table> | Diam. | Height | Sight Glass | Fuse Plug | Sw.Port. | 3.00 | 10.13 | | | | Inlet | Outlet | Moist. Ind. | HPRelief | Gauge Port. | 3/8" MIOR | 3/8" FOR | | Yes | Yes |
|--|-------------|-------------|-------------|-------------|----------|------|-------|-----|-----|-----|-------|--------|-------------|----------|-------------|-------------|-------------|-----|-----|-----|---|-------|--------|-------------|-----------|----------|------|------|-----|-----|-----|-------|--------|-------------|----------|-------------|------------|------------|--|-----|-----|---|-------|--------|-------------|-----------|----------|------|-------|--|--|-----|-------|--------|-------------|----------|-------------|-----------|-----------|--|-----|-----|
| Diam. | Height | Sight Glass | Fuse Plug | Sw.Port. | | | | | | | | | | | | | | | | | | | | | | | | | | | | | | | | | | | | | | | | | | | | | | | | | | | | | | | | | | |
| 3.00 | 9.19 | | | Yes | | | | | | | | | | | | | | | | | | | | | | | | | | | | | | | | | | | | | | | | | | | | | | | | | | | | | | | | | | |
| Inlet | Outlet | Moist. Ind. | HPRelief | Gauge Port. | | | | | | | | | | | | | | | | | | | | | | | | | | | | | | | | | | | | | | | | | | | | | | | | | | | | | | | | | | |
| 3/8" MIOR | 3/8" MIOR | | Yes | Yes | | | | | | | | | | | | | | | | | | | | | | | | | | | | | | | | | | | | | | | | | | | | | | | | | | | | | | | | | | |
| Diam. | Height | Sight Glass | Fuse Plug | Sw.Port. | | | | | | | | | | | | | | | | | | | | | | | | | | | | | | | | | | | | | | | | | | | | | | | | | | | | | | | | | | |
| 3.00 | 8.25 | | | | | | | | | | | | | | | | | | | | | | | | | | | | | | | | | | | | | | | | | | | | | | | | | | | | | | | | | | | | | |
| Inlet | Outlet | Moist. Ind. | HPRelief | Gauge Port. | | | | | | | | | | | | | | | | | | | | | | | | | | | | | | | | | | | | | | | | | | | | | | | | | | | | | | | | | | |
| 3/8" MIOR | 3/8" FOR | | Yes | Yes | | | | | | | | | | | | | | | | | | | | | | | | | | | | | | | | | | | | | | | | | | | | | | | | | | | | | | | | | | |
| Diam. | Height | Sight Glass | Fuse Plug | Sw.Port. | | | | | | | | | | | | | | | | | | | | | | | | | | | | | | | | | | | | | | | | | | | | | | | | | | | | | | | | | | |
| 3.00 | 10.13 | | | | | | | | | | | | | | | | | | | | | | | | | | | | | | | | | | | | | | | | | | | | | | | | | | | | | | | | | | | | | |
| Inlet | Outlet | Moist. Ind. | HPRelief | Gauge Port. | | | | | | | | | | | | | | | | | | | | | | | | | | | | | | | | | | | | | | | | | | | | | | | | | | | | | | | | | | |
| 3/8" MIOR | 3/8" FOR | | Yes | Yes | | | | | | | | | | | | | | | | | | | | | | | | | | | | | | | | | | | | | | | | | | | | | | | | | | | | | | | | | | |
| <p>407017</p>  <table border="1"> <thead> <tr> <th>Diam.</th> <th>Height</th> <th>Sight Glass</th> <th>Fuse Plug</th> <th>Sw.Port.</th> </tr> </thead> <tbody> <tr> <td>2.50</td> <td>6.00</td> <td></td> <td></td> <td></td> </tr> <tr> <th>Inlet</th> <th>Outlet</th> <th>Moist. Ind.</th> <th>HPRelief</th> <th>Gauge Port.</th> </tr> <tr> <td>QUICK DISC.</td> <td>QUICK DISC.</td> <td></td> <td>Yes</td> <td>Yes</td> </tr> </tbody> </table> | Diam. | Height | Sight Glass | Fuse Plug | Sw.Port. | 2.50 | 6.00 | | | | Inlet | Outlet | Moist. Ind. | HPRelief | Gauge Port. | QUICK DISC. | QUICK DISC. | | Yes | Yes | <p>407018</p>  <table border="1"> <thead> <tr> <th>Diam.</th> <th>Height</th> <th>Sight Glass</th> <th>Fuse Plug</th> <th>Sw.Port.</th> </tr> </thead> <tbody> <tr> <td>3.00</td> <td>8.25</td> <td></td> <td></td> <td></td> </tr> <tr> <th>Inlet</th> <th>Outlet</th> <th>Moist. Ind.</th> <th>HPRelief</th> <th>Gauge Port.</th> </tr> <tr> <td>3/8" MIOR</td> <td>3/8" FOR</td> <td></td> <td>Yes</td> <td>Yes</td> </tr> </tbody> </table> | Diam. | Height | Sight Glass | Fuse Plug | Sw.Port. | 3.00 | 8.25 | | | | Inlet | Outlet | Moist. Ind. | HPRelief | Gauge Port. | 3/8" MIOR | 3/8" FOR | | Yes | Yes | <p>407019</p>  <table border="1"> <thead> <tr> <th>Diam.</th> <th>Height</th> <th>Sight Glass</th> <th>Fuse Plug</th> <th>Sw.Port.</th> </tr> </thead> <tbody> <tr> <td>3.00</td> <td>6.25</td> <td></td> <td></td> <td></td> </tr> <tr> <th>Inlet</th> <th>Outlet</th> <th>Moist. Ind.</th> <th>HPRelief</th> <th>Gauge Port.</th> </tr> <tr> <td>3/8" MIOR</td> <td>3/8" MIOR</td> <td></td> <td>Yes</td> <td></td> </tr> </tbody> </table> | Diam. | Height | Sight Glass | Fuse Plug | Sw.Port. | 3.00 | 6.25 | | | | Inlet | Outlet | Moist. Ind. | HPRelief | Gauge Port. | 3/8" MIOR | 3/8" MIOR | | Yes | |
| Diam. | Height | Sight Glass | Fuse Plug | Sw.Port. | | | | | | | | | | | | | | | | | | | | | | | | | | | | | | | | | | | | | | | | | | | | | | | | | | | | | | | | | | |
| 2.50 | 6.00 | | | | | | | | | | | | | | | | | | | | | | | | | | | | | | | | | | | | | | | | | | | | | | | | | | | | | | | | | | | | | |
| Inlet | Outlet | Moist. Ind. | HPRelief | Gauge Port. | | | | | | | | | | | | | | | | | | | | | | | | | | | | | | | | | | | | | | | | | | | | | | | | | | | | | | | | | | |
| QUICK DISC. | QUICK DISC. | | Yes | Yes | | | | | | | | | | | | | | | | | | | | | | | | | | | | | | | | | | | | | | | | | | | | | | | | | | | | | | | | | | |
| Diam. | Height | Sight Glass | Fuse Plug | Sw.Port. | | | | | | | | | | | | | | | | | | | | | | | | | | | | | | | | | | | | | | | | | | | | | | | | | | | | | | | | | | |
| 3.00 | 8.25 | | | | | | | | | | | | | | | | | | | | | | | | | | | | | | | | | | | | | | | | | | | | | | | | | | | | | | | | | | | | | |
| Inlet | Outlet | Moist. Ind. | HPRelief | Gauge Port. | | | | | | | | | | | | | | | | | | | | | | | | | | | | | | | | | | | | | | | | | | | | | | | | | | | | | | | | | | |
| 3/8" MIOR | 3/8" FOR | | Yes | Yes | | | | | | | | | | | | | | | | | | | | | | | | | | | | | | | | | | | | | | | | | | | | | | | | | | | | | | | | | | |
| Diam. | Height | Sight Glass | Fuse Plug | Sw.Port. | | | | | | | | | | | | | | | | | | | | | | | | | | | | | | | | | | | | | | | | | | | | | | | | | | | | | | | | | | |
| 3.00 | 6.25 | | | | | | | | | | | | | | | | | | | | | | | | | | | | | | | | | | | | | | | | | | | | | | | | | | | | | | | | | | | | | |
| Inlet | Outlet | Moist. Ind. | HPRelief | Gauge Port. | | | | | | | | | | | | | | | | | | | | | | | | | | | | | | | | | | | | | | | | | | | | | | | | | | | | | | | | | | |
| 3/8" MIOR | 3/8" MIOR | | Yes | | | | | | | | | | | | | | | | | | | | | | | | | | | | | | | | | | | | | | | | | | | | | | | | | | | | | | | | | | | |
| <p>407020</p>  <table border="1"> <thead> <tr> <th>Diam.</th> <th>Height</th> <th>Sight Glass</th> <th>Fuse Plug</th> <th>Sw.Port.</th> </tr> </thead> <tbody> <tr> <td>2.50</td> <td>8.00</td> <td>Yes</td> <td>Yes</td> <td></td> </tr> <tr> <th>Inlet</th> <th>Outlet</th> <th>Moist. Ind.</th> <th>HPRelief</th> <th>Gauge Port.</th> </tr> <tr> <td>3/8" MIOR</td> <td>3/8" MIOR</td> <td></td> <td></td> <td></td> </tr> </tbody> </table> | Diam. | Height | Sight Glass | Fuse Plug | Sw.Port. | 2.50 | 8.00 | Yes | Yes | | Inlet | Outlet | Moist. Ind. | HPRelief | Gauge Port. | 3/8" MIOR | 3/8" MIOR | | | | <p>407021</p>  <table border="1"> <thead> <tr> <th>Diam.</th> <th>Height</th> <th>Sight Glass</th> <th>Fuse Plug</th> <th>Sw.Port.</th> </tr> </thead> <tbody> <tr> <td>2.50</td> <td>8.00</td> <td></td> <td></td> <td></td> </tr> <tr> <th>Inlet</th> <th>Outlet</th> <th>Moist. Ind.</th> <th>HPRelief</th> <th>Gauge Port.</th> </tr> <tr> <td>5/16" Barb</td> <td>5/16" Barb</td> <td></td> <td></td> <td></td> </tr> </tbody> </table> | Diam. | Height | Sight Glass | Fuse Plug | Sw.Port. | 2.50 | 8.00 | | | | Inlet | Outlet | Moist. Ind. | HPRelief | Gauge Port. | 5/16" Barb | 5/16" Barb | | | | <p>407022</p>  <table border="1"> <thead> <tr> <th>Diam.</th> <th>Height</th> <th>Sight Glass</th> <th>Fuse Plug</th> <th>Sw.Port.</th> </tr> </thead> <tbody> <tr> <td>4.00</td> <td>8.00</td> <td></td> <td></td> <td></td> </tr> <tr> <th>Inlet</th> <th>Outlet</th> <th>Moist. Ind.</th> <th>HPRelief</th> <th>Gauge Port.</th> </tr> <tr> <td>3/8" MIOR</td> <td>3/8" MIOR</td> <td></td> <td></td> <td></td> </tr> </tbody> </table> | Diam. | Height | Sight Glass | Fuse Plug | Sw.Port. | 4.00 | 8.00 | | | | Inlet | Outlet | Moist. Ind. | HPRelief | Gauge Port. | 3/8" MIOR | 3/8" MIOR | | | |
| Diam. | Height | Sight Glass | Fuse Plug | Sw.Port. | | | | | | | | | | | | | | | | | | | | | | | | | | | | | | | | | | | | | | | | | | | | | | | | | | | | | | | | | | |
| 2.50 | 8.00 | Yes | Yes | | | | | | | | | | | | | | | | | | | | | | | | | | | | | | | | | | | | | | | | | | | | | | | | | | | | | | | | | | | |
| Inlet | Outlet | Moist. Ind. | HPRelief | Gauge Port. | | | | | | | | | | | | | | | | | | | | | | | | | | | | | | | | | | | | | | | | | | | | | | | | | | | | | | | | | | |
| 3/8" MIOR | 3/8" MIOR | | | | | | | | | | | | | | | | | | | | | | | | | | | | | | | | | | | | | | | | | | | | | | | | | | | | | | | | | | | | | |
| Diam. | Height | Sight Glass | Fuse Plug | Sw.Port. | | | | | | | | | | | | | | | | | | | | | | | | | | | | | | | | | | | | | | | | | | | | | | | | | | | | | | | | | | |
| 2.50 | 8.00 | | | | | | | | | | | | | | | | | | | | | | | | | | | | | | | | | | | | | | | | | | | | | | | | | | | | | | | | | | | | | |
| Inlet | Outlet | Moist. Ind. | HPRelief | Gauge Port. | | | | | | | | | | | | | | | | | | | | | | | | | | | | | | | | | | | | | | | | | | | | | | | | | | | | | | | | | | |
| 5/16" Barb | 5/16" Barb | | | | | | | | | | | | | | | | | | | | | | | | | | | | | | | | | | | | | | | | | | | | | | | | | | | | | | | | | | | | | |
| Diam. | Height | Sight Glass | Fuse Plug | Sw.Port. | | | | | | | | | | | | | | | | | | | | | | | | | | | | | | | | | | | | | | | | | | | | | | | | | | | | | | | | | | |
| 4.00 | 8.00 | | | | | | | | | | | | | | | | | | | | | | | | | | | | | | | | | | | | | | | | | | | | | | | | | | | | | | | | | | | | | |
| Inlet | Outlet | Moist. Ind. | HPRelief | Gauge Port. | | | | | | | | | | | | | | | | | | | | | | | | | | | | | | | | | | | | | | | | | | | | | | | | | | | | | | | | | | |
| 3/8" MIOR | 3/8" MIOR | | | | | | | | | | | | | | | | | | | | | | | | | | | | | | | | | | | | | | | | | | | | | | | | | | | | | | | | | | | | | |
| <p>407023</p>  <table border="1"> <thead> <tr> <th>Diam.</th> <th>Height</th> <th>Sight Glass</th> <th>Fuse Plug</th> <th>Sw.Port.</th> </tr> </thead> <tbody> <tr> <td>3.00</td> <td>10.50</td> <td></td> <td>Yes</td> <td>Yes</td> </tr> <tr> <th>Inlet</th> <th>Outlet</th> <th>Moist. Ind.</th> <th>HPRelief</th> <th>Gauge Port.</th> </tr> <tr> <td>7/16" FOR</td> <td>3/8" FOR</td> <td>Yes</td> <td></td> <td></td> </tr> </tbody> </table> | Diam. | Height | Sight Glass | Fuse Plug | Sw.Port. | 3.00 | 10.50 | | Yes | Yes | Inlet | Outlet | Moist. Ind. | HPRelief | Gauge Port. | 7/16" FOR | 3/8" FOR | Yes | | | <p>407024 <i>STANDARD</i> 407024A <i>OEM</i></p>  <table border="1"> <thead> <tr> <th>Diam.</th> <th>Height</th> <th>Sight Glass</th> <th>Fuse Plug</th> <th>Sw.Port.</th> </tr> </thead> <tbody> <tr> <td>2.50</td> <td>8.00</td> <td>Yes</td> <td>Yes</td> <td>Yes</td> </tr> <tr> <th>Inlet</th> <th>Outlet</th> <th>Moist. Ind.</th> <th>HPRelief</th> <th>Gauge Port.</th> </tr> <tr> <td>3/8" MIOR</td> <td>3/8" MIOR</td> <td></td> <td></td> <td></td> </tr> </tbody> </table> | Diam. | Height | Sight Glass | Fuse Plug | Sw.Port. | 2.50 | 8.00 | Yes | Yes | Yes | Inlet | Outlet | Moist. Ind. | HPRelief | Gauge Port. | 3/8" MIOR | 3/8" MIOR | | | | <p>407025</p>  <table border="1"> <thead> <tr> <th>Diam.</th> <th>Height</th> <th>Sight Glass</th> <th>Fuse Plug</th> <th>Sw.Port.</th> </tr> </thead> <tbody> <tr> <td>3.00</td> <td>7.75</td> <td></td> <td></td> <td>Yes</td> </tr> <tr> <th>Inlet</th> <th>Outlet</th> <th>Moist. Ind.</th> <th>HPRelief</th> <th>Gauge Port.</th> </tr> <tr> <td>3/8" MIOR</td> <td>3/8" MIOR</td> <td></td> <td></td> <td></td> </tr> </tbody> </table> | Diam. | Height | Sight Glass | Fuse Plug | Sw.Port. | 3.00 | 7.75 | | | Yes | Inlet | Outlet | Moist. Ind. | HPRelief | Gauge Port. | 3/8" MIOR | 3/8" MIOR | | | |
| Diam. | Height | Sight Glass | Fuse Plug | Sw.Port. | | | | | | | | | | | | | | | | | | | | | | | | | | | | | | | | | | | | | | | | | | | | | | | | | | | | | | | | | | |
| 3.00 | 10.50 | | Yes | Yes | | | | | | | | | | | | | | | | | | | | | | | | | | | | | | | | | | | | | | | | | | | | | | | | | | | | | | | | | | |
| Inlet | Outlet | Moist. Ind. | HPRelief | Gauge Port. | | | | | | | | | | | | | | | | | | | | | | | | | | | | | | | | | | | | | | | | | | | | | | | | | | | | | | | | | | |
| 7/16" FOR | 3/8" FOR | Yes | | | | | | | | | | | | | | | | | | | | | | | | | | | | | | | | | | | | | | | | | | | | | | | | | | | | | | | | | | | | |
| Diam. | Height | Sight Glass | Fuse Plug | Sw.Port. | | | | | | | | | | | | | | | | | | | | | | | | | | | | | | | | | | | | | | | | | | | | | | | | | | | | | | | | | | |
| 2.50 | 8.00 | Yes | Yes | Yes | | | | | | | | | | | | | | | | | | | | | | | | | | | | | | | | | | | | | | | | | | | | | | | | | | | | | | | | | | |
| Inlet | Outlet | Moist. Ind. | HPRelief | Gauge Port. | | | | | | | | | | | | | | | | | | | | | | | | | | | | | | | | | | | | | | | | | | | | | | | | | | | | | | | | | | |
| 3/8" MIOR | 3/8" MIOR | | | | | | | | | | | | | | | | | | | | | | | | | | | | | | | | | | | | | | | | | | | | | | | | | | | | | | | | | | | | | |
| Diam. | Height | Sight Glass | Fuse Plug | Sw.Port. | | | | | | | | | | | | | | | | | | | | | | | | | | | | | | | | | | | | | | | | | | | | | | | | | | | | | | | | | | |
| 3.00 | 7.75 | | | Yes | | | | | | | | | | | | | | | | | | | | | | | | | | | | | | | | | | | | | | | | | | | | | | | | | | | | | | | | | | |
| Inlet | Outlet | Moist. Ind. | HPRelief | Gauge Port. | | | | | | | | | | | | | | | | | | | | | | | | | | | | | | | | | | | | | | | | | | | | | | | | | | | | | | | | | | |
| 3/8" MIOR | 3/8" MIOR | | | | | | | | | | | | | | | | | | | | | | | | | | | | | | | | | | | | | | | | | | | | | | | | | | | | | | | | | | | | | |

RECEIVER/DRIERS

PARTS

DRIERS

407026

| Diam. | Height | Sight Glass | Fuse Plug | Sw.Port |
|-----------|-----------|-------------|-----------|------------|
| 3.00 | 8.00 | Yes | Yes | Yes |
| Inlet | Outlet | Moist. Ind. | HPRelief | Gauge Port |
| 3/8" MIOR | 3/8" MIOR | | | |

407027
D712-587

| Diam. | Height | Sight Glass | Fuse Plug | Sw.Port |
|-----------|-----------|-------------|-----------|------------|
| 2.75 | 10.00 | Yes | Yes | |
| Inlet | Outlet | Moist. Ind. | HPRelief | Gauge Port |
| 3/8" MIOR | 3/8" MIOR | | | |

407028

| Diam. | Height | Sight Glass | Fuse Plug | Sw.Port |
|-----------|-----------|-------------|-----------|------------|
| 2.75 | 6.50 | | Yes | Yes |
| Inlet | Outlet | Moist. Ind. | HPRelief | Gauge Port |
| 3/8" MIOR | 3/8" MIOR | | | |

407029

| Diam. | Height | Sight Glass | Fuse Plug | Sw.Port |
|-----------|-----------|-------------|-----------|------------|
| 2.75 | 6.50 | | Yes | Bin |
| Inlet | Outlet | Moist. Ind. | HPRelief | Gauge Port |
| 3/8" MIOR | 3/8" MIOR | | | |

407030

| Diam. | Height | Sight Glass | Fuse Plug | Sw.Port |
|-----------|-----------|-------------|-----------|------------|
| 3.00 | 10.13 | | | |
| Inlet | Outlet | Moist. Ind. | HPRelief | Gauge Port |
| 3/8" MIOR | 3/8" MIOR | | Yes | |

407031

| Diam. | Height | Sight Glass | Fuse Plug | Sw.Port |
|-----------|----------|-------------|-----------|------------|
| 3.00 | 10.13 | Yes | | |
| Inlet | Outlet | Moist. Ind. | HPRelief | Gauge Port |
| 3/8" MIOR | 3/8" FOR | | Yes | Yes |

407032

| Diam. | Height | Sight Glass | Fuse Plug | Sw.Port |
|----------|-----------|-------------|-----------|------------|
| 4.00 | 7.50 | Yes | | |
| Inlet | Outlet | Moist. Ind. | HPRelief | Gauge Port |
| 3/8" FOR | 3/8" MIOR | | | |

407033

| Diam. | Height | Sight Glass | Fuse Plug | Sw.Port |
|-----------|----------|-------------|-----------|------------|
| 3.00 | 8.50 | Yes | | |
| Inlet | Outlet | Moist. Ind. | HPRelief | Gauge Port |
| 7/16" FOR | 3/8" FOR | | | |

407034

| Diam. | Height | Sight Glass | Fuse Plug | Sw.Port |
|-----------|-----------|-------------|-----------|------------|
| 3.00 | 10.25 | Yes | | |
| Inlet | Outlet | Moist. Ind. | HPRelief | Gauge Port |
| 3/8" MIOR | 3/8" MIOR | | Yes | |

407035

| Diam. | Height | Sight Glass | Fuse Plug | Sw.Port |
|-----------|----------|-------------|-----------|------------|
| 3.00 | 8.25 | Yes | | |
| Inlet | Outlet | Moist. Ind. | HPRelief | Gauge Port |
| 3/8" MIOR | 3/8" FOR | | Yes | Yes |

407036

| Diam. | Height | Sight Glass | Fuse Plug | Sw.Port |
|-----------|-----------|-------------|-----------|------------|
| 2.75 | 10.00 | Yes | Yes | |
| Inlet | Outlet | Moist. Ind. | HPRelief | Gauge Port |
| 3/8" MIOR | 3/8" MIOR | | | |

407037

| Diam. | Height | Sight Glass | Fuse Plug | Sw.Port |
|-----------|-----------|-------------|-----------|------------|
| 2.75 | 10.00 | | | |
| Inlet | Outlet | Moist. Ind. | HPRelief | Gauge Port |
| 3/8" MIOR | 3/8" MIOR | | | |

| <p>407038</p>  <table border="1"> <thead> <tr> <th>Diam.</th> <th>Height</th> <th>Sight Glass</th> <th>Fuse Plug</th> <th>Sw.Port.</th> </tr> </thead> <tbody> <tr> <td>2.50</td> <td>9.75</td> <td></td> <td></td> <td></td> </tr> <tr> <th>Inlet</th> <th>Outlet</th> <th>Moist. Ind.</th> <th>HPRelief</th> <th>Gauge Port.</th> </tr> <tr> <td>3/8" MIOR</td> <td>3/8" MIOR</td> <td></td> <td></td> <td></td> </tr> </tbody> </table> | Diam. | Height | Sight Glass | Fuse Plug | Sw.Port. | 2.50 | 9.75 | | | | Inlet | Outlet | Moist. Ind. | HPRelief | Gauge Port. | 3/8" MIOR | 3/8" MIOR | | | | <p>407039</p>  <table border="1"> <thead> <tr> <th>Diam.</th> <th>Height</th> <th>Sight Glass</th> <th>Fuse Plug</th> <th>Sw.Port.</th> </tr> </thead> <tbody> <tr> <td>2.50</td> <td>9.75</td> <td>Yes</td> <td></td> <td></td> </tr> <tr> <th>Inlet</th> <th>Outlet</th> <th>Moist. Ind.</th> <th>HPRelief</th> <th>Gauge Port.</th> </tr> <tr> <td>3/8" MIOR</td> <td>3/8" MIOR</td> <td></td> <td></td> <td></td> </tr> </tbody> </table> | Diam. | Height | Sight Glass | Fuse Plug | Sw.Port. | 2.50 | 9.75 | Yes | | | Inlet | Outlet | Moist. Ind. | HPRelief | Gauge Port. | 3/8" MIOR | 3/8" MIOR | | | | <p>407041</p>  <table border="1"> <thead> <tr> <th>Diam.</th> <th>Height</th> <th>Sight Glass</th> <th>Fuse Plug</th> <th>Sw.Port.</th> </tr> </thead> <tbody> <tr> <td>3.00</td> <td>6.25</td> <td>Yes</td> <td></td> <td>Yes</td> </tr> <tr> <th>Inlet</th> <th>Outlet</th> <th>Moist. Ind.</th> <th>HPRelief</th> <th>Gauge Port.</th> </tr> <tr> <td>3/8" MIOR</td> <td>3/8" MIOR</td> <td></td> <td></td> <td>Yes</td> </tr> </tbody> </table> | Diam. | Height | Sight Glass | Fuse Plug | Sw.Port. | 3.00 | 6.25 | Yes | | Yes | Inlet | Outlet | Moist. Ind. | HPRelief | Gauge Port. | 3/8" MIOR | 3/8" MIOR | | | Yes |
|---|-------------|-------------|-------------|-------------|----------|------|------|-----|-----|-----|-------|--------|-------------|----------|-------------|-----------|-----------|-----|-----|--|---|-------|--------|-------------|-----------|----------|------|-------|-----|-----|--|-------|--------|-------------|----------|-------------|-------------|-------------|--|-----|-----|--|-------|--------|-------------|-----------|----------|------|-------|-----|--|-----|-------|--------|-------------|----------|-------------|-------------|-------------|--|-----|-----|
| Diam. | Height | Sight Glass | Fuse Plug | Sw.Port. | | | | | | | | | | | | | | | | | | | | | | | | | | | | | | | | | | | | | | | | | | | | | | | | | | | | | | | | | | |
| 2.50 | 9.75 | | | | | | | | | | | | | | | | | | | | | | | | | | | | | | | | | | | | | | | | | | | | | | | | | | | | | | | | | | | | | |
| Inlet | Outlet | Moist. Ind. | HPRelief | Gauge Port. | | | | | | | | | | | | | | | | | | | | | | | | | | | | | | | | | | | | | | | | | | | | | | | | | | | | | | | | | | |
| 3/8" MIOR | 3/8" MIOR | | | | | | | | | | | | | | | | | | | | | | | | | | | | | | | | | | | | | | | | | | | | | | | | | | | | | | | | | | | | | |
| Diam. | Height | Sight Glass | Fuse Plug | Sw.Port. | | | | | | | | | | | | | | | | | | | | | | | | | | | | | | | | | | | | | | | | | | | | | | | | | | | | | | | | | | |
| 2.50 | 9.75 | Yes | | | | | | | | | | | | | | | | | | | | | | | | | | | | | | | | | | | | | | | | | | | | | | | | | | | | | | | | | | | | |
| Inlet | Outlet | Moist. Ind. | HPRelief | Gauge Port. | | | | | | | | | | | | | | | | | | | | | | | | | | | | | | | | | | | | | | | | | | | | | | | | | | | | | | | | | | |
| 3/8" MIOR | 3/8" MIOR | | | | | | | | | | | | | | | | | | | | | | | | | | | | | | | | | | | | | | | | | | | | | | | | | | | | | | | | | | | | | |
| Diam. | Height | Sight Glass | Fuse Plug | Sw.Port. | | | | | | | | | | | | | | | | | | | | | | | | | | | | | | | | | | | | | | | | | | | | | | | | | | | | | | | | | | |
| 3.00 | 6.25 | Yes | | Yes | | | | | | | | | | | | | | | | | | | | | | | | | | | | | | | | | | | | | | | | | | | | | | | | | | | | | | | | | | |
| Inlet | Outlet | Moist. Ind. | HPRelief | Gauge Port. | | | | | | | | | | | | | | | | | | | | | | | | | | | | | | | | | | | | | | | | | | | | | | | | | | | | | | | | | | |
| 3/8" MIOR | 3/8" MIOR | | | Yes | | | | | | | | | | | | | | | | | | | | | | | | | | | | | | | | | | | | | | | | | | | | | | | | | | | | | | | | | | |
| <p>407042 <i>STANDARD</i> 407042A <i>OEM</i></p>  <table border="1"> <thead> <tr> <th>Diam.</th> <th>Height</th> <th>Sight Glass</th> <th>Fuse Plug</th> <th>Sw.Port.</th> </tr> </thead> <tbody> <tr> <td>3.00</td> <td>8.25</td> <td>Yes</td> <td>Yes</td> <td>Yes</td> </tr> <tr> <th>Inlet</th> <th>Outlet</th> <th>Moist. Ind.</th> <th>HPRelief</th> <th>Gauge Port.</th> </tr> <tr> <td>3/8" MIOR</td> <td>3/8" MIOR</td> <td>Yes</td> <td>Yes</td> <td></td> </tr> </tbody> </table> | Diam. | Height | Sight Glass | Fuse Plug | Sw.Port. | 3.00 | 8.25 | Yes | Yes | Yes | Inlet | Outlet | Moist. Ind. | HPRelief | Gauge Port. | 3/8" MIOR | 3/8" MIOR | Yes | Yes | | <p>407043</p>  <table border="1"> <thead> <tr> <th>Diam.</th> <th>Height</th> <th>Sight Glass</th> <th>Fuse Plug</th> <th>Sw.Port.</th> </tr> </thead> <tbody> <tr> <td>3.00</td> <td>10.13</td> <td>Yes</td> <td>Yes</td> <td></td> </tr> <tr> <th>Inlet</th> <th>Outlet</th> <th>Moist. Ind.</th> <th>HPRelief</th> <th>Gauge Port.</th> </tr> <tr> <td>QUICK DISC.</td> <td>QUICK DISC.</td> <td></td> <td>Yes</td> <td>Yes</td> </tr> </tbody> </table> | Diam. | Height | Sight Glass | Fuse Plug | Sw.Port. | 3.00 | 10.13 | Yes | Yes | | Inlet | Outlet | Moist. Ind. | HPRelief | Gauge Port. | QUICK DISC. | QUICK DISC. | | Yes | Yes | <p>407044</p>  <table border="1"> <thead> <tr> <th>Diam.</th> <th>Height</th> <th>Sight Glass</th> <th>Fuse Plug</th> <th>Sw.Port.</th> </tr> </thead> <tbody> <tr> <td>3.00</td> <td>10.13</td> <td></td> <td></td> <td></td> </tr> <tr> <th>Inlet</th> <th>Outlet</th> <th>Moist. Ind.</th> <th>HPRelief</th> <th>Gauge Port.</th> </tr> <tr> <td>QUICK DISC.</td> <td>QUICK DISC.</td> <td></td> <td>Yes</td> <td>Yes</td> </tr> </tbody> </table> | Diam. | Height | Sight Glass | Fuse Plug | Sw.Port. | 3.00 | 10.13 | | | | Inlet | Outlet | Moist. Ind. | HPRelief | Gauge Port. | QUICK DISC. | QUICK DISC. | | Yes | Yes |
| Diam. | Height | Sight Glass | Fuse Plug | Sw.Port. | | | | | | | | | | | | | | | | | | | | | | | | | | | | | | | | | | | | | | | | | | | | | | | | | | | | | | | | | | |
| 3.00 | 8.25 | Yes | Yes | Yes | | | | | | | | | | | | | | | | | | | | | | | | | | | | | | | | | | | | | | | | | | | | | | | | | | | | | | | | | | |
| Inlet | Outlet | Moist. Ind. | HPRelief | Gauge Port. | | | | | | | | | | | | | | | | | | | | | | | | | | | | | | | | | | | | | | | | | | | | | | | | | | | | | | | | | | |
| 3/8" MIOR | 3/8" MIOR | Yes | Yes | | | | | | | | | | | | | | | | | | | | | | | | | | | | | | | | | | | | | | | | | | | | | | | | | | | | | | | | | | | |
| Diam. | Height | Sight Glass | Fuse Plug | Sw.Port. | | | | | | | | | | | | | | | | | | | | | | | | | | | | | | | | | | | | | | | | | | | | | | | | | | | | | | | | | | |
| 3.00 | 10.13 | Yes | Yes | | | | | | | | | | | | | | | | | | | | | | | | | | | | | | | | | | | | | | | | | | | | | | | | | | | | | | | | | | | |
| Inlet | Outlet | Moist. Ind. | HPRelief | Gauge Port. | | | | | | | | | | | | | | | | | | | | | | | | | | | | | | | | | | | | | | | | | | | | | | | | | | | | | | | | | | |
| QUICK DISC. | QUICK DISC. | | Yes | Yes | | | | | | | | | | | | | | | | | | | | | | | | | | | | | | | | | | | | | | | | | | | | | | | | | | | | | | | | | | |
| Diam. | Height | Sight Glass | Fuse Plug | Sw.Port. | | | | | | | | | | | | | | | | | | | | | | | | | | | | | | | | | | | | | | | | | | | | | | | | | | | | | | | | | | |
| 3.00 | 10.13 | | | | | | | | | | | | | | | | | | | | | | | | | | | | | | | | | | | | | | | | | | | | | | | | | | | | | | | | | | | | | |
| Inlet | Outlet | Moist. Ind. | HPRelief | Gauge Port. | | | | | | | | | | | | | | | | | | | | | | | | | | | | | | | | | | | | | | | | | | | | | | | | | | | | | | | | | | |
| QUICK DISC. | QUICK DISC. | | Yes | Yes | | | | | | | | | | | | | | | | | | | | | | | | | | | | | | | | | | | | | | | | | | | | | | | | | | | | | | | | | | |
| <p>407045</p>  <table border="1"> <thead> <tr> <th>Diam.</th> <th>Height</th> <th>Sight Glass</th> <th>Fuse Plug</th> <th>Sw.Port.</th> </tr> </thead> <tbody> <tr> <td>3.00</td> <td>6.00</td> <td>Yes</td> <td>Yes</td> <td></td> </tr> <tr> <th>Inlet</th> <th>Outlet</th> <th>Moist. Ind.</th> <th>HPRelief</th> <th>Gauge Port.</th> </tr> <tr> <td>3/8" MFL</td> <td>3/8" MFL</td> <td></td> <td></td> <td></td> </tr> </tbody> </table> | Diam. | Height | Sight Glass | Fuse Plug | Sw.Port. | 3.00 | 6.00 | Yes | Yes | | Inlet | Outlet | Moist. Ind. | HPRelief | Gauge Port. | 3/8" MFL | 3/8" MFL | | | | <p>407046</p>  <table border="1"> <thead> <tr> <th>Diam.</th> <th>Height</th> <th>Sight Glass</th> <th>Fuse Plug</th> <th>Sw.Port.</th> </tr> </thead> <tbody> <tr> <td>2.50</td> <td>9.63</td> <td></td> <td></td> <td></td> </tr> <tr> <th>Inlet</th> <th>Outlet</th> <th>Moist. Ind.</th> <th>HPRelief</th> <th>Gauge Port.</th> </tr> <tr> <td>3/8" MIOR</td> <td>3/8" MIOR</td> <td></td> <td></td> <td></td> </tr> </tbody> </table> | Diam. | Height | Sight Glass | Fuse Plug | Sw.Port. | 2.50 | 9.63 | | | | Inlet | Outlet | Moist. Ind. | HPRelief | Gauge Port. | 3/8" MIOR | 3/8" MIOR | | | | <p>407047</p>  <table border="1"> <thead> <tr> <th>Diam.</th> <th>Height</th> <th>Sight Glass</th> <th>Fuse Plug</th> <th>Sw.Port.</th> </tr> </thead> <tbody> <tr> <td>2.50</td> <td>7.75</td> <td></td> <td></td> <td></td> </tr> <tr> <th>Inlet</th> <th>Outlet</th> <th>Moist. Ind.</th> <th>HPRelief</th> <th>Gauge Port.</th> </tr> <tr> <td>3/8" MIOR</td> <td>3/8" MIOR</td> <td></td> <td></td> <td></td> </tr> </tbody> </table> | Diam. | Height | Sight Glass | Fuse Plug | Sw.Port. | 2.50 | 7.75 | | | | Inlet | Outlet | Moist. Ind. | HPRelief | Gauge Port. | 3/8" MIOR | 3/8" MIOR | | | |
| Diam. | Height | Sight Glass | Fuse Plug | Sw.Port. | | | | | | | | | | | | | | | | | | | | | | | | | | | | | | | | | | | | | | | | | | | | | | | | | | | | | | | | | | |
| 3.00 | 6.00 | Yes | Yes | | | | | | | | | | | | | | | | | | | | | | | | | | | | | | | | | | | | | | | | | | | | | | | | | | | | | | | | | | | |
| Inlet | Outlet | Moist. Ind. | HPRelief | Gauge Port. | | | | | | | | | | | | | | | | | | | | | | | | | | | | | | | | | | | | | | | | | | | | | | | | | | | | | | | | | | |
| 3/8" MFL | 3/8" MFL | | | | | | | | | | | | | | | | | | | | | | | | | | | | | | | | | | | | | | | | | | | | | | | | | | | | | | | | | | | | | |
| Diam. | Height | Sight Glass | Fuse Plug | Sw.Port. | | | | | | | | | | | | | | | | | | | | | | | | | | | | | | | | | | | | | | | | | | | | | | | | | | | | | | | | | | |
| 2.50 | 9.63 | | | | | | | | | | | | | | | | | | | | | | | | | | | | | | | | | | | | | | | | | | | | | | | | | | | | | | | | | | | | | |
| Inlet | Outlet | Moist. Ind. | HPRelief | Gauge Port. | | | | | | | | | | | | | | | | | | | | | | | | | | | | | | | | | | | | | | | | | | | | | | | | | | | | | | | | | | |
| 3/8" MIOR | 3/8" MIOR | | | | | | | | | | | | | | | | | | | | | | | | | | | | | | | | | | | | | | | | | | | | | | | | | | | | | | | | | | | | | |
| Diam. | Height | Sight Glass | Fuse Plug | Sw.Port. | | | | | | | | | | | | | | | | | | | | | | | | | | | | | | | | | | | | | | | | | | | | | | | | | | | | | | | | | | |
| 2.50 | 7.75 | | | | | | | | | | | | | | | | | | | | | | | | | | | | | | | | | | | | | | | | | | | | | | | | | | | | | | | | | | | | | |
| Inlet | Outlet | Moist. Ind. | HPRelief | Gauge Port. | | | | | | | | | | | | | | | | | | | | | | | | | | | | | | | | | | | | | | | | | | | | | | | | | | | | | | | | | | |
| 3/8" MIOR | 3/8" MIOR | | | | | | | | | | | | | | | | | | | | | | | | | | | | | | | | | | | | | | | | | | | | | | | | | | | | | | | | | | | | | |
| <p>407048</p>  <table border="1"> <thead> <tr> <th>Diam.</th> <th>Height</th> <th>Sight Glass</th> <th>Fuse Plug</th> <th>Sw.Port.</th> </tr> </thead> <tbody> <tr> <td>3.00</td> <td>9.00</td> <td>Yes</td> <td></td> <td></td> </tr> <tr> <th>Inlet</th> <th>Outlet</th> <th>Moist. Ind.</th> <th>HPRelief</th> <th>Gauge Port.</th> </tr> <tr> <td>3/8" MIOR</td> <td>3/8" MIOR</td> <td></td> <td>Yes</td> <td></td> </tr> </tbody> </table> | Diam. | Height | Sight Glass | Fuse Plug | Sw.Port. | 3.00 | 9.00 | Yes | | | Inlet | Outlet | Moist. Ind. | HPRelief | Gauge Port. | 3/8" MIOR | 3/8" MIOR | | Yes | | <p>407049</p>  <table border="1"> <thead> <tr> <th>Diam.</th> <th>Height</th> <th>Sight Glass</th> <th>Fuse Plug</th> <th>Sw.Port.</th> </tr> </thead> <tbody> <tr> <td>3.00</td> <td>8.63</td> <td>Yes</td> <td></td> <td></td> </tr> <tr> <th>Inlet</th> <th>Outlet</th> <th>Moist. Ind.</th> <th>HPRelief</th> <th>Gauge Port.</th> </tr> <tr> <td>3/8" MIOR</td> <td>3/8" MIOR</td> <td></td> <td></td> <td></td> </tr> </tbody> </table> | Diam. | Height | Sight Glass | Fuse Plug | Sw.Port. | 3.00 | 8.63 | Yes | | | Inlet | Outlet | Moist. Ind. | HPRelief | Gauge Port. | 3/8" MIOR | 3/8" MIOR | | | | <p>407050</p>  <table border="1"> <thead> <tr> <th>Diam.</th> <th>Height</th> <th>Sight Glass</th> <th>Fuse Plug</th> <th>Sw.Port.</th> </tr> </thead> <tbody> <tr> <td>3.00</td> <td>11.00</td> <td></td> <td></td> <td></td> </tr> <tr> <th>Inlet</th> <th>Outlet</th> <th>Moist. Ind.</th> <th>HPRelief</th> <th>Gauge Port.</th> </tr> <tr> <td>3/8" MFL</td> <td>3/8" MFL</td> <td></td> <td></td> <td></td> </tr> </tbody> </table> | Diam. | Height | Sight Glass | Fuse Plug | Sw.Port. | 3.00 | 11.00 | | | | Inlet | Outlet | Moist. Ind. | HPRelief | Gauge Port. | 3/8" MFL | 3/8" MFL | | | |
| Diam. | Height | Sight Glass | Fuse Plug | Sw.Port. | | | | | | | | | | | | | | | | | | | | | | | | | | | | | | | | | | | | | | | | | | | | | | | | | | | | | | | | | | |
| 3.00 | 9.00 | Yes | | | | | | | | | | | | | | | | | | | | | | | | | | | | | | | | | | | | | | | | | | | | | | | | | | | | | | | | | | | | |
| Inlet | Outlet | Moist. Ind. | HPRelief | Gauge Port. | | | | | | | | | | | | | | | | | | | | | | | | | | | | | | | | | | | | | | | | | | | | | | | | | | | | | | | | | | |
| 3/8" MIOR | 3/8" MIOR | | Yes | | | | | | | | | | | | | | | | | | | | | | | | | | | | | | | | | | | | | | | | | | | | | | | | | | | | | | | | | | | |
| Diam. | Height | Sight Glass | Fuse Plug | Sw.Port. | | | | | | | | | | | | | | | | | | | | | | | | | | | | | | | | | | | | | | | | | | | | | | | | | | | | | | | | | | |
| 3.00 | 8.63 | Yes | | | | | | | | | | | | | | | | | | | | | | | | | | | | | | | | | | | | | | | | | | | | | | | | | | | | | | | | | | | | |
| Inlet | Outlet | Moist. Ind. | HPRelief | Gauge Port. | | | | | | | | | | | | | | | | | | | | | | | | | | | | | | | | | | | | | | | | | | | | | | | | | | | | | | | | | | |
| 3/8" MIOR | 3/8" MIOR | | | | | | | | | | | | | | | | | | | | | | | | | | | | | | | | | | | | | | | | | | | | | | | | | | | | | | | | | | | | | |
| Diam. | Height | Sight Glass | Fuse Plug | Sw.Port. | | | | | | | | | | | | | | | | | | | | | | | | | | | | | | | | | | | | | | | | | | | | | | | | | | | | | | | | | | |
| 3.00 | 11.00 | | | | | | | | | | | | | | | | | | | | | | | | | | | | | | | | | | | | | | | | | | | | | | | | | | | | | | | | | | | | | |
| Inlet | Outlet | Moist. Ind. | HPRelief | Gauge Port. | | | | | | | | | | | | | | | | | | | | | | | | | | | | | | | | | | | | | | | | | | | | | | | | | | | | | | | | | | |
| 3/8" MFL | 3/8" MFL | | | | | | | | | | | | | | | | | | | | | | | | | | | | | | | | | | | | | | | | | | | | | | | | | | | | | | | | | | | | | |

RECEIVER/DRIERS

PARTS

DRIERS

| <p>407051</p>  <p>Navistar 539049</p> <table border="1"> <thead> <tr> <th>Diam.</th> <th>Height</th> <th>Sight Glass</th> <th>Fuse Plug</th> <th>Sw.Port</th> </tr> </thead> <tbody> <tr> <td>4.00</td> <td>6.88</td> <td>Yes</td> <td></td> <td></td> </tr> <tr> <th>Inlet</th> <th>Outlet</th> <th>Moist. Ind.</th> <th>HPRelief</th> <th>Gauge Port</th> </tr> <tr> <td>3/8" MFL</td> <td>3/8" MFL</td> <td></td> <td></td> <td></td> </tr> </tbody> </table> | Diam. | Height | Sight Glass | Fuse Plug | Sw.Port | 4.00 | 6.88 | Yes | | | Inlet | Outlet | Moist. Ind. | HPRelief | Gauge Port | 3/8" MFL | 3/8" MFL | | | | <p>407052</p>  <table border="1"> <thead> <tr> <th>Diam.</th> <th>Height</th> <th>Sight Glass</th> <th>Fuse Plug</th> <th>Sw.Port</th> </tr> </thead> <tbody> <tr> <td>3.00</td> <td>9.19</td> <td></td> <td></td> <td></td> </tr> <tr> <th>Inlet</th> <th>Outlet</th> <th>Moist. Ind.</th> <th>HPRelief</th> <th>Gauge Port</th> </tr> <tr> <td>3/8" MIOR</td> <td>3/8" MIOR</td> <td></td> <td>Yes</td> <td>Yes</td> </tr> </tbody> </table> | Diam. | Height | Sight Glass | Fuse Plug | Sw.Port | 3.00 | 9.19 | | | | Inlet | Outlet | Moist. Ind. | HPRelief | Gauge Port | 3/8" MIOR | 3/8" MIOR | | Yes | Yes | <p>407053</p>  <table border="1"> <thead> <tr> <th>Diam.</th> <th>Height</th> <th>Sight Glass</th> <th>Fuse Plug</th> <th>Sw.Port</th> </tr> </thead> <tbody> <tr> <td>4.00</td> <td>5.00</td> <td></td> <td>Yes</td> <td></td> </tr> <tr> <th>Inlet</th> <th>Outlet</th> <th>Moist. Ind.</th> <th>HPRelief</th> <th>Gauge Port</th> </tr> <tr> <td>3/8" MIOR</td> <td>3/8" MIOR</td> <td></td> <td></td> <td></td> </tr> </tbody> </table> | Diam. | Height | Sight Glass | Fuse Plug | Sw.Port | 4.00 | 5.00 | | Yes | | Inlet | Outlet | Moist. Ind. | HPRelief | Gauge Port | 3/8" MIOR | 3/8" MIOR | | | |
|---|-----------|-------------|-------------|------------|---------|------|------|-----|-----|-----|-------|--------|-------------|----------|------------|-----------|-----------|--|-----|--|---|-------|--------|-------------|-----------|---------|------|-------|-----|-----|-----|-------|--------|-------------|----------|------------|-----------|-----------|--|-----|-----|--|-------|--------|-------------|-----------|---------|------|------|-----|-----|-----|-------|--------|-------------|----------|------------|-----------|-----------|--|-----|-----|
| Diam. | Height | Sight Glass | Fuse Plug | Sw.Port | | | | | | | | | | | | | | | | | | | | | | | | | | | | | | | | | | | | | | | | | | | | | | | | | | | | | | | | | | |
| 4.00 | 6.88 | Yes | | | | | | | | | | | | | | | | | | | | | | | | | | | | | | | | | | | | | | | | | | | | | | | | | | | | | | | | | | | | |
| Inlet | Outlet | Moist. Ind. | HPRelief | Gauge Port | | | | | | | | | | | | | | | | | | | | | | | | | | | | | | | | | | | | | | | | | | | | | | | | | | | | | | | | | | |
| 3/8" MFL | 3/8" MFL | | | | | | | | | | | | | | | | | | | | | | | | | | | | | | | | | | | | | | | | | | | | | | | | | | | | | | | | | | | | | |
| Diam. | Height | Sight Glass | Fuse Plug | Sw.Port | | | | | | | | | | | | | | | | | | | | | | | | | | | | | | | | | | | | | | | | | | | | | | | | | | | | | | | | | | |
| 3.00 | 9.19 | | | | | | | | | | | | | | | | | | | | | | | | | | | | | | | | | | | | | | | | | | | | | | | | | | | | | | | | | | | | | |
| Inlet | Outlet | Moist. Ind. | HPRelief | Gauge Port | | | | | | | | | | | | | | | | | | | | | | | | | | | | | | | | | | | | | | | | | | | | | | | | | | | | | | | | | | |
| 3/8" MIOR | 3/8" MIOR | | Yes | Yes | | | | | | | | | | | | | | | | | | | | | | | | | | | | | | | | | | | | | | | | | | | | | | | | | | | | | | | | | | |
| Diam. | Height | Sight Glass | Fuse Plug | Sw.Port | | | | | | | | | | | | | | | | | | | | | | | | | | | | | | | | | | | | | | | | | | | | | | | | | | | | | | | | | | |
| 4.00 | 5.00 | | Yes | | | | | | | | | | | | | | | | | | | | | | | | | | | | | | | | | | | | | | | | | | | | | | | | | | | | | | | | | | | |
| Inlet | Outlet | Moist. Ind. | HPRelief | Gauge Port | | | | | | | | | | | | | | | | | | | | | | | | | | | | | | | | | | | | | | | | | | | | | | | | | | | | | | | | | | |
| 3/8" MIOR | 3/8" MIOR | | | | | | | | | | | | | | | | | | | | | | | | | | | | | | | | | | | | | | | | | | | | | | | | | | | | | | | | | | | | | |
| <p>407054</p>  <table border="1"> <thead> <tr> <th>Diam.</th> <th>Height</th> <th>Sight Glass</th> <th>Fuse Plug</th> <th>Sw.Port</th> </tr> </thead> <tbody> <tr> <td>3.00</td> <td>7.38</td> <td>Yes</td> <td>Yes</td> <td>LP</td> </tr> <tr> <th>Inlet</th> <th>Outlet</th> <th>Moist. Ind.</th> <th>HPRelief</th> <th>Gauge Port</th> </tr> <tr> <td>3/8" MIOR</td> <td>3/8" MIOR</td> <td></td> <td>Yes</td> <td></td> </tr> </tbody> </table> | Diam. | Height | Sight Glass | Fuse Plug | Sw.Port | 3.00 | 7.38 | Yes | Yes | LP | Inlet | Outlet | Moist. Ind. | HPRelief | Gauge Port | 3/8" MIOR | 3/8" MIOR | | Yes | | <p>407055</p> <p>W/TRINARY SWITCH</p>  <table border="1"> <thead> <tr> <th>Diam.</th> <th>Height</th> <th>Sight Glass</th> <th>Fuse Plug</th> <th>Sw.Port</th> </tr> </thead> <tbody> <tr> <td>2.75</td> <td>6.50</td> <td></td> <td>Yes</td> <td>TRI</td> </tr> <tr> <th>Inlet</th> <th>Outlet</th> <th>Moist. Ind.</th> <th>HPRelief</th> <th>Gauge Port</th> </tr> <tr> <td>3/8" MIOR</td> <td>3/8" MIOR</td> <td></td> <td></td> <td></td> </tr> </tbody> </table> | Diam. | Height | Sight Glass | Fuse Plug | Sw.Port | 2.75 | 6.50 | | Yes | TRI | Inlet | Outlet | Moist. Ind. | HPRelief | Gauge Port | 3/8" MIOR | 3/8" MIOR | | | | <p>407056</p>  <table border="1"> <thead> <tr> <th>Diam.</th> <th>Height</th> <th>Sight Glass</th> <th>Fuse Plug</th> <th>Sw.Port</th> </tr> </thead> <tbody> <tr> <td>3.00</td> <td>6.50</td> <td>Yes</td> <td></td> <td></td> </tr> <tr> <th>Inlet</th> <th>Outlet</th> <th>Moist. Ind.</th> <th>HPRelief</th> <th>Gauge Port</th> </tr> <tr> <td>3/8" MIOR</td> <td>3/8" MIOR</td> <td></td> <td>Yes</td> <td>Yes</td> </tr> </tbody> </table> | Diam. | Height | Sight Glass | Fuse Plug | Sw.Port | 3.00 | 6.50 | Yes | | | Inlet | Outlet | Moist. Ind. | HPRelief | Gauge Port | 3/8" MIOR | 3/8" MIOR | | Yes | Yes |
| Diam. | Height | Sight Glass | Fuse Plug | Sw.Port | | | | | | | | | | | | | | | | | | | | | | | | | | | | | | | | | | | | | | | | | | | | | | | | | | | | | | | | | | |
| 3.00 | 7.38 | Yes | Yes | LP | | | | | | | | | | | | | | | | | | | | | | | | | | | | | | | | | | | | | | | | | | | | | | | | | | | | | | | | | | |
| Inlet | Outlet | Moist. Ind. | HPRelief | Gauge Port | | | | | | | | | | | | | | | | | | | | | | | | | | | | | | | | | | | | | | | | | | | | | | | | | | | | | | | | | | |
| 3/8" MIOR | 3/8" MIOR | | Yes | | | | | | | | | | | | | | | | | | | | | | | | | | | | | | | | | | | | | | | | | | | | | | | | | | | | | | | | | | | |
| Diam. | Height | Sight Glass | Fuse Plug | Sw.Port | | | | | | | | | | | | | | | | | | | | | | | | | | | | | | | | | | | | | | | | | | | | | | | | | | | | | | | | | | |
| 2.75 | 6.50 | | Yes | TRI | | | | | | | | | | | | | | | | | | | | | | | | | | | | | | | | | | | | | | | | | | | | | | | | | | | | | | | | | | |
| Inlet | Outlet | Moist. Ind. | HPRelief | Gauge Port | | | | | | | | | | | | | | | | | | | | | | | | | | | | | | | | | | | | | | | | | | | | | | | | | | | | | | | | | | |
| 3/8" MIOR | 3/8" MIOR | | | | | | | | | | | | | | | | | | | | | | | | | | | | | | | | | | | | | | | | | | | | | | | | | | | | | | | | | | | | | |
| Diam. | Height | Sight Glass | Fuse Plug | Sw.Port | | | | | | | | | | | | | | | | | | | | | | | | | | | | | | | | | | | | | | | | | | | | | | | | | | | | | | | | | | |
| 3.00 | 6.50 | Yes | | | | | | | | | | | | | | | | | | | | | | | | | | | | | | | | | | | | | | | | | | | | | | | | | | | | | | | | | | | | |
| Inlet | Outlet | Moist. Ind. | HPRelief | Gauge Port | | | | | | | | | | | | | | | | | | | | | | | | | | | | | | | | | | | | | | | | | | | | | | | | | | | | | | | | | | |
| 3/8" MIOR | 3/8" MIOR | | Yes | Yes | | | | | | | | | | | | | | | | | | | | | | | | | | | | | | | | | | | | | | | | | | | | | | | | | | | | | | | | | | |
| <p>407057</p>  <table border="1"> <thead> <tr> <th>Diam.</th> <th>Height</th> <th>Sight Glass</th> <th>Fuse Plug</th> <th>Sw.Port</th> </tr> </thead> <tbody> <tr> <td>2.50</td> <td>8.75</td> <td></td> <td></td> <td></td> </tr> <tr> <th>Inlet</th> <th>Outlet</th> <th>Moist. Ind.</th> <th>HPRelief</th> <th>Gauge Port</th> </tr> <tr> <td>3/8" MIOR</td> <td>3/8" MIOR</td> <td></td> <td></td> <td></td> </tr> </tbody> </table> | Diam. | Height | Sight Glass | Fuse Plug | Sw.Port | 2.50 | 8.75 | | | | Inlet | Outlet | Moist. Ind. | HPRelief | Gauge Port | 3/8" MIOR | 3/8" MIOR | | | | <p>407058</p>  <table border="1"> <thead> <tr> <th>Diam.</th> <th>Height</th> <th>Sight Glass</th> <th>Fuse Plug</th> <th>Sw.Port</th> </tr> </thead> <tbody> <tr> <td>3.00</td> <td>10.13</td> <td>Yes</td> <td></td> <td></td> </tr> <tr> <th>Inlet</th> <th>Outlet</th> <th>Moist. Ind.</th> <th>HPRelief</th> <th>Gauge Port</th> </tr> <tr> <td>3/8" MIOR</td> <td>3/8" MIOR</td> <td></td> <td>Yes</td> <td></td> </tr> </tbody> </table> | Diam. | Height | Sight Glass | Fuse Plug | Sw.Port | 3.00 | 10.13 | Yes | | | Inlet | Outlet | Moist. Ind. | HPRelief | Gauge Port | 3/8" MIOR | 3/8" MIOR | | Yes | | <p>407059</p>  <table border="1"> <thead> <tr> <th>Diam.</th> <th>Height</th> <th>Sight Glass</th> <th>Fuse Plug</th> <th>Sw.Port</th> </tr> </thead> <tbody> <tr> <td>3.00</td> <td>7.88</td> <td></td> <td>Yes</td> <td></td> </tr> <tr> <th>Inlet</th> <th>Outlet</th> <th>Moist. Ind.</th> <th>HPRelief</th> <th>Gauge Port</th> </tr> <tr> <td>3/8" MIOR</td> <td>3/8" MIOR</td> <td></td> <td>Yes</td> <td></td> </tr> </tbody> </table> | Diam. | Height | Sight Glass | Fuse Plug | Sw.Port | 3.00 | 7.88 | | Yes | | Inlet | Outlet | Moist. Ind. | HPRelief | Gauge Port | 3/8" MIOR | 3/8" MIOR | | Yes | |
| Diam. | Height | Sight Glass | Fuse Plug | Sw.Port | | | | | | | | | | | | | | | | | | | | | | | | | | | | | | | | | | | | | | | | | | | | | | | | | | | | | | | | | | |
| 2.50 | 8.75 | | | | | | | | | | | | | | | | | | | | | | | | | | | | | | | | | | | | | | | | | | | | | | | | | | | | | | | | | | | | | |
| Inlet | Outlet | Moist. Ind. | HPRelief | Gauge Port | | | | | | | | | | | | | | | | | | | | | | | | | | | | | | | | | | | | | | | | | | | | | | | | | | | | | | | | | | |
| 3/8" MIOR | 3/8" MIOR | | | | | | | | | | | | | | | | | | | | | | | | | | | | | | | | | | | | | | | | | | | | | | | | | | | | | | | | | | | | | |
| Diam. | Height | Sight Glass | Fuse Plug | Sw.Port | | | | | | | | | | | | | | | | | | | | | | | | | | | | | | | | | | | | | | | | | | | | | | | | | | | | | | | | | | |
| 3.00 | 10.13 | Yes | | | | | | | | | | | | | | | | | | | | | | | | | | | | | | | | | | | | | | | | | | | | | | | | | | | | | | | | | | | | |
| Inlet | Outlet | Moist. Ind. | HPRelief | Gauge Port | | | | | | | | | | | | | | | | | | | | | | | | | | | | | | | | | | | | | | | | | | | | | | | | | | | | | | | | | | |
| 3/8" MIOR | 3/8" MIOR | | Yes | | | | | | | | | | | | | | | | | | | | | | | | | | | | | | | | | | | | | | | | | | | | | | | | | | | | | | | | | | | |
| Diam. | Height | Sight Glass | Fuse Plug | Sw.Port | | | | | | | | | | | | | | | | | | | | | | | | | | | | | | | | | | | | | | | | | | | | | | | | | | | | | | | | | | |
| 3.00 | 7.88 | | Yes | | | | | | | | | | | | | | | | | | | | | | | | | | | | | | | | | | | | | | | | | | | | | | | | | | | | | | | | | | | |
| Inlet | Outlet | Moist. Ind. | HPRelief | Gauge Port | | | | | | | | | | | | | | | | | | | | | | | | | | | | | | | | | | | | | | | | | | | | | | | | | | | | | | | | | | |
| 3/8" MIOR | 3/8" MIOR | | Yes | | | | | | | | | | | | | | | | | | | | | | | | | | | | | | | | | | | | | | | | | | | | | | | | | | | | | | | | | | | |
| <p>407060</p>  <table border="1"> <thead> <tr> <th>Diam.</th> <th>Height</th> <th>Sight Glass</th> <th>Fuse Plug</th> <th>Sw.Port</th> </tr> </thead> <tbody> <tr> <td>3.00</td> <td>6.75</td> <td>Yes</td> <td>Yes</td> <td>Yes</td> </tr> <tr> <th>Inlet</th> <th>Outlet</th> <th>Moist. Ind.</th> <th>HPRelief</th> <th>Gauge Port</th> </tr> <tr> <td>3/8" MIOR</td> <td>3/8" MIOR</td> <td></td> <td>Yes</td> <td></td> </tr> </tbody> </table> | Diam. | Height | Sight Glass | Fuse Plug | Sw.Port | 3.00 | 6.75 | Yes | Yes | Yes | Inlet | Outlet | Moist. Ind. | HPRelief | Gauge Port | 3/8" MIOR | 3/8" MIOR | | Yes | | <p>407061</p>  <table border="1"> <thead> <tr> <th>Diam.</th> <th>Height</th> <th>Sight Glass</th> <th>Fuse Plug</th> <th>Sw.Port</th> </tr> </thead> <tbody> <tr> <td>3.00</td> <td>6.00</td> <td></td> <td>Yes</td> <td>Yes</td> </tr> <tr> <th>Inlet</th> <th>Outlet</th> <th>Moist. Ind.</th> <th>HPRelief</th> <th>Gauge Port</th> </tr> <tr> <td>3/8" MIOR</td> <td>3/8" MIOR</td> <td></td> <td>Yes</td> <td></td> </tr> </tbody> </table> | Diam. | Height | Sight Glass | Fuse Plug | Sw.Port | 3.00 | 6.00 | | Yes | Yes | Inlet | Outlet | Moist. Ind. | HPRelief | Gauge Port | 3/8" MIOR | 3/8" MIOR | | Yes | | <p>407062</p>  <table border="1"> <thead> <tr> <th>Diam.</th> <th>Height</th> <th>Sight Glass</th> <th>Fuse Plug</th> <th>Sw.Port</th> </tr> </thead> <tbody> <tr> <td>3.00</td> <td>6.00</td> <td></td> <td></td> <td>Yes</td> </tr> <tr> <th>Inlet</th> <th>Outlet</th> <th>Moist. Ind.</th> <th>HPRelief</th> <th>Gauge Port</th> </tr> <tr> <td>3/8" MIOR</td> <td>3/8" MIOR</td> <td></td> <td></td> <td></td> </tr> </tbody> </table> | Diam. | Height | Sight Glass | Fuse Plug | Sw.Port | 3.00 | 6.00 | | | Yes | Inlet | Outlet | Moist. Ind. | HPRelief | Gauge Port | 3/8" MIOR | 3/8" MIOR | | | |
| Diam. | Height | Sight Glass | Fuse Plug | Sw.Port | | | | | | | | | | | | | | | | | | | | | | | | | | | | | | | | | | | | | | | | | | | | | | | | | | | | | | | | | | |
| 3.00 | 6.75 | Yes | Yes | Yes | | | | | | | | | | | | | | | | | | | | | | | | | | | | | | | | | | | | | | | | | | | | | | | | | | | | | | | | | | |
| Inlet | Outlet | Moist. Ind. | HPRelief | Gauge Port | | | | | | | | | | | | | | | | | | | | | | | | | | | | | | | | | | | | | | | | | | | | | | | | | | | | | | | | | | |
| 3/8" MIOR | 3/8" MIOR | | Yes | | | | | | | | | | | | | | | | | | | | | | | | | | | | | | | | | | | | | | | | | | | | | | | | | | | | | | | | | | | |
| Diam. | Height | Sight Glass | Fuse Plug | Sw.Port | | | | | | | | | | | | | | | | | | | | | | | | | | | | | | | | | | | | | | | | | | | | | | | | | | | | | | | | | | |
| 3.00 | 6.00 | | Yes | Yes | | | | | | | | | | | | | | | | | | | | | | | | | | | | | | | | | | | | | | | | | | | | | | | | | | | | | | | | | | |
| Inlet | Outlet | Moist. Ind. | HPRelief | Gauge Port | | | | | | | | | | | | | | | | | | | | | | | | | | | | | | | | | | | | | | | | | | | | | | | | | | | | | | | | | | |
| 3/8" MIOR | 3/8" MIOR | | Yes | | | | | | | | | | | | | | | | | | | | | | | | | | | | | | | | | | | | | | | | | | | | | | | | | | | | | | | | | | | |
| Diam. | Height | Sight Glass | Fuse Plug | Sw.Port | | | | | | | | | | | | | | | | | | | | | | | | | | | | | | | | | | | | | | | | | | | | | | | | | | | | | | | | | | |
| 3.00 | 6.00 | | | Yes | | | | | | | | | | | | | | | | | | | | | | | | | | | | | | | | | | | | | | | | | | | | | | | | | | | | | | | | | | |
| Inlet | Outlet | Moist. Ind. | HPRelief | Gauge Port | | | | | | | | | | | | | | | | | | | | | | | | | | | | | | | | | | | | | | | | | | | | | | | | | | | | | | | | | | |
| 3/8" MIOR | 3/8" MIOR | | | | | | | | | | | | | | | | | | | | | | | | | | | | | | | | | | | | | | | | | | | | | | | | | | | | | | | | | | | | | |

| <p>407063</p>  <table border="1"> <thead> <tr> <th>Diam.</th> <th>Height</th> <th>Sight Glass</th> <th>Fuse Plug</th> <th>Sw.Port.</th> </tr> </thead> <tbody> <tr> <td>2.75</td> <td>10.00</td> <td></td> <td></td> <td></td> </tr> <tr> <th>Inlet</th> <th>Outlet</th> <th>Moist. Ind.</th> <th>HPRelief</th> <th>Gauge Port.</th> </tr> <tr> <td>3/8" MIOR</td> <td>3/8" MIOR</td> <td></td> <td></td> <td></td> </tr> </tbody> </table> | Diam. | Height | Sight Glass | Fuse Plug | Sw.Port. | 2.75 | 10.00 | | | | Inlet | Outlet | Moist. Ind. | HPRelief | Gauge Port. | 3/8" MIOR | 3/8" MIOR | | | | <p>407064 <i>STANDARD</i> 407064A <i>OEM</i></p>  <table border="1"> <thead> <tr> <th>Diam.</th> <th>Height</th> <th>Sight Glass</th> <th>Fuse Plug</th> <th>Sw.Port.</th> </tr> </thead> <tbody> <tr> <td>2.75</td> <td>10.00</td> <td>Yes</td> <td></td> <td></td> </tr> <tr> <th>Inlet</th> <th>Outlet</th> <th>Moist. Ind.</th> <th>HPRelief</th> <th>Gauge Port.</th> </tr> <tr> <td>3/8" MIOR</td> <td>3/8" MIOR</td> <td></td> <td>Yes</td> <td>Yes</td> </tr> </tbody> </table> | Diam. | Height | Sight Glass | Fuse Plug | Sw.Port. | 2.75 | 10.00 | Yes | | | Inlet | Outlet | Moist. Ind. | HPRelief | Gauge Port. | 3/8" MIOR | 3/8" MIOR | | Yes | Yes | <p>407065</p>  <table border="1"> <thead> <tr> <th>Diam.</th> <th>Height</th> <th>Sight Glass</th> <th>Fuse Plug</th> <th>Sw.Port.</th> </tr> </thead> <tbody> <tr> <td>2.75</td> <td>10.00</td> <td>Yes</td> <td>Yes</td> <td>Yes</td> </tr> <tr> <th>Inlet</th> <th>Outlet</th> <th>Moist. Ind.</th> <th>HPRelief</th> <th>Gauge Port.</th> </tr> <tr> <td>3/8" MIOR</td> <td>3/8" MIOR</td> <td></td> <td></td> <td></td> </tr> </tbody> </table> | Diam. | Height | Sight Glass | Fuse Plug | Sw.Port. | 2.75 | 10.00 | Yes | Yes | Yes | Inlet | Outlet | Moist. Ind. | HPRelief | Gauge Port. | 3/8" MIOR | 3/8" MIOR | | | |
|--|-------------|-------------|-------------|-------------|----------|------|-------|-----|-----|-----|-------|--------|-------------|----------|-------------|-------------|-------------|--|-----|-----|---|-------|--------|-------------|-----------|----------|------|-------|-----|-----|-----|-------|--------|-------------|----------|-------------|-------------|-------------|--|-----|-----|---|-------|--------|-------------|-----------|----------|------|-------|-----|-----|-----|-------|--------|-------------|----------|-------------|-----------|-----------|--|--|--|
| Diam. | Height | Sight Glass | Fuse Plug | Sw.Port. | | | | | | | | | | | | | | | | | | | | | | | | | | | | | | | | | | | | | | | | | | | | | | | | | | | | | | | | | | |
| 2.75 | 10.00 | | | | | | | | | | | | | | | | | | | | | | | | | | | | | | | | | | | | | | | | | | | | | | | | | | | | | | | | | | | | | |
| Inlet | Outlet | Moist. Ind. | HPRelief | Gauge Port. | | | | | | | | | | | | | | | | | | | | | | | | | | | | | | | | | | | | | | | | | | | | | | | | | | | | | | | | | | |
| 3/8" MIOR | 3/8" MIOR | | | | | | | | | | | | | | | | | | | | | | | | | | | | | | | | | | | | | | | | | | | | | | | | | | | | | | | | | | | | | |
| Diam. | Height | Sight Glass | Fuse Plug | Sw.Port. | | | | | | | | | | | | | | | | | | | | | | | | | | | | | | | | | | | | | | | | | | | | | | | | | | | | | | | | | | |
| 2.75 | 10.00 | Yes | | | | | | | | | | | | | | | | | | | | | | | | | | | | | | | | | | | | | | | | | | | | | | | | | | | | | | | | | | | | |
| Inlet | Outlet | Moist. Ind. | HPRelief | Gauge Port. | | | | | | | | | | | | | | | | | | | | | | | | | | | | | | | | | | | | | | | | | | | | | | | | | | | | | | | | | | |
| 3/8" MIOR | 3/8" MIOR | | Yes | Yes | | | | | | | | | | | | | | | | | | | | | | | | | | | | | | | | | | | | | | | | | | | | | | | | | | | | | | | | | | |
| Diam. | Height | Sight Glass | Fuse Plug | Sw.Port. | | | | | | | | | | | | | | | | | | | | | | | | | | | | | | | | | | | | | | | | | | | | | | | | | | | | | | | | | | |
| 2.75 | 10.00 | Yes | Yes | Yes | | | | | | | | | | | | | | | | | | | | | | | | | | | | | | | | | | | | | | | | | | | | | | | | | | | | | | | | | | |
| Inlet | Outlet | Moist. Ind. | HPRelief | Gauge Port. | | | | | | | | | | | | | | | | | | | | | | | | | | | | | | | | | | | | | | | | | | | | | | | | | | | | | | | | | | |
| 3/8" MIOR | 3/8" MIOR | | | | | | | | | | | | | | | | | | | | | | | | | | | | | | | | | | | | | | | | | | | | | | | | | | | | | | | | | | | | | |
| <p>407066</p>  <table border="1"> <thead> <tr> <th>Diam.</th> <th>Height</th> <th>Sight Glass</th> <th>Fuse Plug</th> <th>Sw.Port.</th> </tr> </thead> <tbody> <tr> <td>2.75</td> <td>10.00</td> <td>Yes</td> <td>Yes</td> <td>Yes</td> </tr> <tr> <th>Inlet</th> <th>Outlet</th> <th>Moist. Ind.</th> <th>HPRelief</th> <th>Gauge Port.</th> </tr> <tr> <td>3/8" MIOR</td> <td>3/8" MIOR</td> <td></td> <td></td> <td></td> </tr> </tbody> </table> | Diam. | Height | Sight Glass | Fuse Plug | Sw.Port. | 2.75 | 10.00 | Yes | Yes | Yes | Inlet | Outlet | Moist. Ind. | HPRelief | Gauge Port. | 3/8" MIOR | 3/8" MIOR | | | | <p>407067</p>  <table border="1"> <thead> <tr> <th>Diam.</th> <th>Height</th> <th>Sight Glass</th> <th>Fuse Plug</th> <th>Sw.Port.</th> </tr> </thead> <tbody> <tr> <td>3.00</td> <td>10.00</td> <td>Yes</td> <td>Yes</td> <td></td> </tr> <tr> <th>Inlet</th> <th>Outlet</th> <th>Moist. Ind.</th> <th>HPRelief</th> <th>Gauge Port.</th> </tr> <tr> <td>QUICK DISC.</td> <td>QUICK DISC.</td> <td></td> <td>Yes</td> <td>Yes</td> </tr> </tbody> </table> | Diam. | Height | Sight Glass | Fuse Plug | Sw.Port. | 3.00 | 10.00 | Yes | Yes | | Inlet | Outlet | Moist. Ind. | HPRelief | Gauge Port. | QUICK DISC. | QUICK DISC. | | Yes | Yes | <p>407068</p>  <table border="1"> <thead> <tr> <th>Diam.</th> <th>Height</th> <th>Sight Glass</th> <th>Fuse Plug</th> <th>Sw.Port.</th> </tr> </thead> <tbody> <tr> <td>3.00</td> <td>9.50</td> <td>Yes</td> <td>Yes</td> <td></td> </tr> <tr> <th>Inlet</th> <th>Outlet</th> <th>Moist. Ind.</th> <th>HPRelief</th> <th>Gauge Port.</th> </tr> <tr> <td>3/8" MFL</td> <td>3/8" MFL</td> <td></td> <td></td> <td></td> </tr> </tbody> </table> | Diam. | Height | Sight Glass | Fuse Plug | Sw.Port. | 3.00 | 9.50 | Yes | Yes | | Inlet | Outlet | Moist. Ind. | HPRelief | Gauge Port. | 3/8" MFL | 3/8" MFL | | | |
| Diam. | Height | Sight Glass | Fuse Plug | Sw.Port. | | | | | | | | | | | | | | | | | | | | | | | | | | | | | | | | | | | | | | | | | | | | | | | | | | | | | | | | | | |
| 2.75 | 10.00 | Yes | Yes | Yes | | | | | | | | | | | | | | | | | | | | | | | | | | | | | | | | | | | | | | | | | | | | | | | | | | | | | | | | | | |
| Inlet | Outlet | Moist. Ind. | HPRelief | Gauge Port. | | | | | | | | | | | | | | | | | | | | | | | | | | | | | | | | | | | | | | | | | | | | | | | | | | | | | | | | | | |
| 3/8" MIOR | 3/8" MIOR | | | | | | | | | | | | | | | | | | | | | | | | | | | | | | | | | | | | | | | | | | | | | | | | | | | | | | | | | | | | | |
| Diam. | Height | Sight Glass | Fuse Plug | Sw.Port. | | | | | | | | | | | | | | | | | | | | | | | | | | | | | | | | | | | | | | | | | | | | | | | | | | | | | | | | | | |
| 3.00 | 10.00 | Yes | Yes | | | | | | | | | | | | | | | | | | | | | | | | | | | | | | | | | | | | | | | | | | | | | | | | | | | | | | | | | | | |
| Inlet | Outlet | Moist. Ind. | HPRelief | Gauge Port. | | | | | | | | | | | | | | | | | | | | | | | | | | | | | | | | | | | | | | | | | | | | | | | | | | | | | | | | | | |
| QUICK DISC. | QUICK DISC. | | Yes | Yes | | | | | | | | | | | | | | | | | | | | | | | | | | | | | | | | | | | | | | | | | | | | | | | | | | | | | | | | | | |
| Diam. | Height | Sight Glass | Fuse Plug | Sw.Port. | | | | | | | | | | | | | | | | | | | | | | | | | | | | | | | | | | | | | | | | | | | | | | | | | | | | | | | | | | |
| 3.00 | 9.50 | Yes | Yes | | | | | | | | | | | | | | | | | | | | | | | | | | | | | | | | | | | | | | | | | | | | | | | | | | | | | | | | | | | |
| Inlet | Outlet | Moist. Ind. | HPRelief | Gauge Port. | | | | | | | | | | | | | | | | | | | | | | | | | | | | | | | | | | | | | | | | | | | | | | | | | | | | | | | | | | |
| 3/8" MFL | 3/8" MFL | | | | | | | | | | | | | | | | | | | | | | | | | | | | | | | | | | | | | | | | | | | | | | | | | | | | | | | | | | | | | |
| <p>407069 <i>STANDARD</i> 407069A <i>OEM</i></p>  <p>Navistar 1619412C1</p> <table border="1"> <thead> <tr> <th>Diam.</th> <th>Height</th> <th>Sight Glass</th> <th>Fuse Plug</th> <th>Sw.Port.</th> </tr> </thead> <tbody> <tr> <td>3.00</td> <td>10.10</td> <td></td> <td></td> <td>Yes</td> </tr> <tr> <th>Inlet</th> <th>Outlet</th> <th>Moist. Ind.</th> <th>HPRelief</th> <th>Gauge Port.</th> </tr> <tr> <td>QUICK DISC.</td> <td>QUICK DISC.</td> <td></td> <td>Yes</td> <td>Yes</td> </tr> </tbody> </table> | Diam. | Height | Sight Glass | Fuse Plug | Sw.Port. | 3.00 | 10.10 | | | Yes | Inlet | Outlet | Moist. Ind. | HPRelief | Gauge Port. | QUICK DISC. | QUICK DISC. | | Yes | Yes | <p>407070</p>  <p>Freightliner A22-32150-00</p> <table border="1"> <thead> <tr> <th>Diam.</th> <th>Height</th> <th>Sight Glass</th> <th>Fuse Plug</th> <th>Sw.Port.</th> </tr> </thead> <tbody> <tr> <td>3.00</td> <td>8.25</td> <td>Yes</td> <td>Yes</td> <td>Yes</td> </tr> <tr> <th>Inlet</th> <th>Outlet</th> <th>Moist. Ind.</th> <th>HPRelief</th> <th>Gauge Port.</th> </tr> <tr> <td>3/8" MIOR</td> <td>3/8" FOR</td> <td></td> <td>Yes</td> <td>Yes</td> </tr> </tbody> </table> | Diam. | Height | Sight Glass | Fuse Plug | Sw.Port. | 3.00 | 8.25 | Yes | Yes | Yes | Inlet | Outlet | Moist. Ind. | HPRelief | Gauge Port. | 3/8" MIOR | 3/8" FOR | | Yes | Yes | <p>407071</p>  <p>Ford E6HZ-19959-A</p> <table border="1"> <thead> <tr> <th>Diam.</th> <th>Height</th> <th>Sight Glass</th> <th>Fuse Plug</th> <th>Sw.Port.</th> </tr> </thead> <tbody> <tr> <td>3.00</td> <td>8.00</td> <td></td> <td></td> <td>Yes</td> </tr> <tr> <th>Inlet</th> <th>Outlet</th> <th>Moist. Ind.</th> <th>HPRelief</th> <th>Gauge Port.</th> </tr> <tr> <td>3/8" MIOR</td> <td>3/8" MIOR</td> <td></td> <td></td> <td></td> </tr> </tbody> </table> | Diam. | Height | Sight Glass | Fuse Plug | Sw.Port. | 3.00 | 8.00 | | | Yes | Inlet | Outlet | Moist. Ind. | HPRelief | Gauge Port. | 3/8" MIOR | 3/8" MIOR | | | |
| Diam. | Height | Sight Glass | Fuse Plug | Sw.Port. | | | | | | | | | | | | | | | | | | | | | | | | | | | | | | | | | | | | | | | | | | | | | | | | | | | | | | | | | | |
| 3.00 | 10.10 | | | Yes | | | | | | | | | | | | | | | | | | | | | | | | | | | | | | | | | | | | | | | | | | | | | | | | | | | | | | | | | | |
| Inlet | Outlet | Moist. Ind. | HPRelief | Gauge Port. | | | | | | | | | | | | | | | | | | | | | | | | | | | | | | | | | | | | | | | | | | | | | | | | | | | | | | | | | | |
| QUICK DISC. | QUICK DISC. | | Yes | Yes | | | | | | | | | | | | | | | | | | | | | | | | | | | | | | | | | | | | | | | | | | | | | | | | | | | | | | | | | | |
| Diam. | Height | Sight Glass | Fuse Plug | Sw.Port. | | | | | | | | | | | | | | | | | | | | | | | | | | | | | | | | | | | | | | | | | | | | | | | | | | | | | | | | | | |
| 3.00 | 8.25 | Yes | Yes | Yes | | | | | | | | | | | | | | | | | | | | | | | | | | | | | | | | | | | | | | | | | | | | | | | | | | | | | | | | | | |
| Inlet | Outlet | Moist. Ind. | HPRelief | Gauge Port. | | | | | | | | | | | | | | | | | | | | | | | | | | | | | | | | | | | | | | | | | | | | | | | | | | | | | | | | | | |
| 3/8" MIOR | 3/8" FOR | | Yes | Yes | | | | | | | | | | | | | | | | | | | | | | | | | | | | | | | | | | | | | | | | | | | | | | | | | | | | | | | | | | |
| Diam. | Height | Sight Glass | Fuse Plug | Sw.Port. | | | | | | | | | | | | | | | | | | | | | | | | | | | | | | | | | | | | | | | | | | | | | | | | | | | | | | | | | | |
| 3.00 | 8.00 | | | Yes | | | | | | | | | | | | | | | | | | | | | | | | | | | | | | | | | | | | | | | | | | | | | | | | | | | | | | | | | | |
| Inlet | Outlet | Moist. Ind. | HPRelief | Gauge Port. | | | | | | | | | | | | | | | | | | | | | | | | | | | | | | | | | | | | | | | | | | | | | | | | | | | | | | | | | | |
| 3/8" MIOR | 3/8" MIOR | | | | | | | | | | | | | | | | | | | | | | | | | | | | | | | | | | | | | | | | | | | | | | | | | | | | | | | | | | | | | |
| <p>407072</p>  <table border="1"> <thead> <tr> <th>Diam.</th> <th>Height</th> <th>Sight Glass</th> <th>Fuse Plug</th> <th>Sw.Port.</th> </tr> </thead> <tbody> <tr> <td>3.00</td> <td>8.25</td> <td></td> <td>Yes</td> <td>Yes</td> </tr> <tr> <th>Inlet</th> <th>Outlet</th> <th>Moist. Ind.</th> <th>HPRelief</th> <th>Gauge Port.</th> </tr> <tr> <td>3/8" MIOR</td> <td>3/8" MIOR</td> <td></td> <td>Yes</td> <td></td> </tr> </tbody> </table> | Diam. | Height | Sight Glass | Fuse Plug | Sw.Port. | 3.00 | 8.25 | | Yes | Yes | Inlet | Outlet | Moist. Ind. | HPRelief | Gauge Port. | 3/8" MIOR | 3/8" MIOR | | Yes | | <p>407073</p>  <p>JD RE40109</p> <table border="1"> <thead> <tr> <th>Diam.</th> <th>Height</th> <th>Sight Glass</th> <th>Fuse Plug</th> <th>Sw.Port.</th> </tr> </thead> <tbody> <tr> <td>4.00</td> <td>7.50</td> <td>Yes</td> <td></td> <td></td> </tr> <tr> <th>Inlet</th> <th>Outlet</th> <th>Moist. Ind.</th> <th>HPRelief</th> <th>Gauge Port.</th> </tr> <tr> <td>3/8" FOR</td> <td>3/8" MIOR</td> <td></td> <td></td> <td></td> </tr> </tbody> </table> | Diam. | Height | Sight Glass | Fuse Plug | Sw.Port. | 4.00 | 7.50 | Yes | | | Inlet | Outlet | Moist. Ind. | HPRelief | Gauge Port. | 3/8" FOR | 3/8" MIOR | | | | <p>407074</p>  <p>JD AL77561</p> <table border="1"> <thead> <tr> <th>Diam.</th> <th>Height</th> <th>Sight Glass</th> <th>Fuse Plug</th> <th>Sw.Port.</th> </tr> </thead> <tbody> <tr> <td>4.00</td> <td>7.75</td> <td>Yes</td> <td></td> <td></td> </tr> <tr> <th>Inlet</th> <th>Outlet</th> <th>Moist. Ind.</th> <th>HPRelief</th> <th>Gauge Port.</th> </tr> <tr> <td>3/8" FOR</td> <td>3/8" MIOR</td> <td></td> <td></td> <td></td> </tr> </tbody> </table> | Diam. | Height | Sight Glass | Fuse Plug | Sw.Port. | 4.00 | 7.75 | Yes | | | Inlet | Outlet | Moist. Ind. | HPRelief | Gauge Port. | 3/8" FOR | 3/8" MIOR | | | |
| Diam. | Height | Sight Glass | Fuse Plug | Sw.Port. | | | | | | | | | | | | | | | | | | | | | | | | | | | | | | | | | | | | | | | | | | | | | | | | | | | | | | | | | | |
| 3.00 | 8.25 | | Yes | Yes | | | | | | | | | | | | | | | | | | | | | | | | | | | | | | | | | | | | | | | | | | | | | | | | | | | | | | | | | | |
| Inlet | Outlet | Moist. Ind. | HPRelief | Gauge Port. | | | | | | | | | | | | | | | | | | | | | | | | | | | | | | | | | | | | | | | | | | | | | | | | | | | | | | | | | | |
| 3/8" MIOR | 3/8" MIOR | | Yes | | | | | | | | | | | | | | | | | | | | | | | | | | | | | | | | | | | | | | | | | | | | | | | | | | | | | | | | | | | |
| Diam. | Height | Sight Glass | Fuse Plug | Sw.Port. | | | | | | | | | | | | | | | | | | | | | | | | | | | | | | | | | | | | | | | | | | | | | | | | | | | | | | | | | | |
| 4.00 | 7.50 | Yes | | | | | | | | | | | | | | | | | | | | | | | | | | | | | | | | | | | | | | | | | | | | | | | | | | | | | | | | | | | | |
| Inlet | Outlet | Moist. Ind. | HPRelief | Gauge Port. | | | | | | | | | | | | | | | | | | | | | | | | | | | | | | | | | | | | | | | | | | | | | | | | | | | | | | | | | | |
| 3/8" FOR | 3/8" MIOR | | | | | | | | | | | | | | | | | | | | | | | | | | | | | | | | | | | | | | | | | | | | | | | | | | | | | | | | | | | | | |
| Diam. | Height | Sight Glass | Fuse Plug | Sw.Port. | | | | | | | | | | | | | | | | | | | | | | | | | | | | | | | | | | | | | | | | | | | | | | | | | | | | | | | | | | |
| 4.00 | 7.75 | Yes | | | | | | | | | | | | | | | | | | | | | | | | | | | | | | | | | | | | | | | | | | | | | | | | | | | | | | | | | | | | |
| Inlet | Outlet | Moist. Ind. | HPRelief | Gauge Port. | | | | | | | | | | | | | | | | | | | | | | | | | | | | | | | | | | | | | | | | | | | | | | | | | | | | | | | | | | |
| 3/8" FOR | 3/8" MIOR | | | | | | | | | | | | | | | | | | | | | | | | | | | | | | | | | | | | | | | | | | | | | | | | | | | | | | | | | | | | | |

RECEIVER/DRIERS

PARTS

DRIERS



407075

| Diam. | Height | Sight Glass | Fuse Plug | Sw.Port |
|----------|----------|-------------|-----------|------------|
| 4.00 | 8.00 | Yes | Yes | |
| Inlet | Outlet | Moist. Ind. | HPRelief | Gauge Port |
| 3/8" MFL | 3/8" MFL | | | |



407076

| Diam. | Height | Sight Glass | Fuse Plug | Sw.Port |
|--------------------|--------|-------------|-----------|------------|
| 4.00 | 9.00 | Yes | | |
| Inlet | Outlet | Moist. Ind. | HPRelief | Gauge Port |
| 3/8" FOR 3/8" MIOR | | | | |



407077

| Diam. | Height | Sight Glass | Fuse Plug | Sw.Port |
|--------------------|--------|-------------|-----------|------------|
| 4.00 | 7.75 | Yes | | |
| Inlet | Outlet | Moist. Ind. | HPRelief | Gauge Port |
| 3/8" FOR 3/8" MIOR | | | | |



407400 *STANDARD*
407400A *OEM*

| Diam. | Height | Sight Glass | Fuse Plug | Sw.Port |
|-----------|-----------|-------------|-----------|------------|
| 3.00 | 7.38 | Yes | Yes | LP |
| Inlet | Outlet | Moist. Ind. | HPRelief | Gauge Port |
| 3/8" MIOR | 3/8" MIOR | | Yes | |



407401

| Diam. | Height | Sight Glass | Fuse Plug | Sw.Port |
|-----------|-----------|-------------|-----------|------------|
| 2.75 | 6.50 | | Yes | TRI |
| Inlet | Outlet | Moist. Ind. | HPRelief | Gauge Port |
| 3/8" MIOR | 3/8" MIOR | | | |



407402 *STANDARD*
407402A *OEM*

| Diam. | Height | Sight Glass | Fuse Plug | Sw.Port |
|-----------|-----------|-------------|-----------|------------|
| 3.00 | 6.50 | Yes | | |
| Inlet | Outlet | Moist. Ind. | HPRelief | Gauge Port |
| 3/8" MIOR | 3/8" MIOR | | Yes | Yes |



407403 *STANDARD*
407403A *OEM*

| Diam. | Height | Sight Glass | Fuse Plug | Sw.Port |
|-----------|-----------|-------------|-----------|------------|
| 2.50 | 8.75 | | | |
| Inlet | Outlet | Moist. Ind. | HPRelief | Gauge Port |
| 3/8" MIOR | 3/8" MIOR | | | |



407404

| Diam. | Height | Sight Glass | Fuse Plug | Sw.Port |
|-----------|-----------|-------------|-----------|------------|
| 3.00 | 10.13 | Yes | | |
| Inlet | Outlet | Moist. Ind. | HPRelief | Gauge Port |
| 3/8" MIOR | 3/8" MIOR | | Yes | |



407405

| Diam. | Height | Sight Glass | Fuse Plug | Sw.Port |
|-----------|-----------|-------------|-----------|------------|
| 3.00 | 7.88 | | Yes | |
| Inlet | Outlet | Moist. Ind. | HPRelief | Gauge Port |
| 3/8" MIOR | 3/8" MIOR | | Yes | |



407412

VOLVO 20490945 or 1018848

| Diam. | Height | Sight Glass | Fuse Plug | Sw.Port |
|-----------|-----------|-------------|-----------|------------|
| 3.00 | 6.75 | Yes | Yes | Yes |
| Inlet | Outlet | Moist. Ind. | HPRelief | Gauge Port |
| 3/8" MIOR | 3/8" MIOR | | Yes | |











407414



| Diam. | Height | Sight Glass | Fuse Plug | Sw.Port |
|-----------|-----------|-------------|-----------|------------|
| 3.00 | 6.75 | Yes | Yes | Yes |
| Inlet | Outlet | Moist. Ind. | HPRelief | Gauge Port |
| 3/8" MIOR | 3/8" MIOR | | Yes | |



407415
D712-594

| Diam. | Height | Sight Glass | Fuse Plug | Sw.Port |
|-----------|-----------|-------------|-----------|------------|
| 3.00 | 6.00 | | Yes | Yes |
| Inlet | Outlet | Moist. Ind. | HPRelief | Gauge Port |
| 3/8" MIOR | 3/8" MIOR | | Yes | |

| <p>407433</p> <p style="text-align: center;">PICTURE NOT AVAILABLE</p> <table border="1"> <thead> <tr> <th>Diam.</th> <th>Height</th> <th>Sight Glass</th> <th>Fuse Plug</th> <th>Sw.Port</th> </tr> </thead> <tbody> <tr> <td>2.75</td> <td>10.00</td> <td></td> <td></td> <td></td> </tr> <tr> <th>Inlet</th> <th>Outlet</th> <th>Moist. Ind.</th> <th>HPRelief</th> <th>Gauge Port</th> </tr> <tr> <td>3/8" MIOR</td> <td>3/8" MIOR</td> <td></td> <td></td> <td></td> </tr> </tbody> </table> | Diam. | Height | Sight Glass | Fuse Plug | Sw.Port | 2.75 | 10.00 | | | | Inlet | Outlet | Moist. Ind. | HPRelief | Gauge Port | 3/8" MIOR | 3/8" MIOR | | | | <p>407443</p>  <table border="1"> <thead> <tr> <th>Diam.</th> <th>Height</th> <th>Sight Glass</th> <th>Fuse Plug</th> <th>Sw.Port</th> </tr> </thead> <tbody> <tr> <td>2.75</td> <td>10.00</td> <td></td> <td></td> <td></td> </tr> <tr> <th>Inlet</th> <th>Outlet</th> <th>Moist. Ind.</th> <th>HPRelief</th> <th>Gauge Port</th> </tr> <tr> <td>3/8" MIOR</td> <td>3/8" MIOR</td> <td></td> <td></td> <td></td> </tr> </tbody> </table> | Diam. | Height | Sight Glass | Fuse Plug | Sw.Port | 2.75 | 10.00 | | | | Inlet | Outlet | Moist. Ind. | HPRelief | Gauge Port | 3/8" MIOR | 3/8" MIOR | | | | <p>407447</p> <p style="text-align: center;">PICTURE NOT AVAILABLE</p> <table border="1"> <thead> <tr> <th>Diam.</th> <th>Height</th> <th>Sight Glass</th> <th>Fuse Plug</th> <th>Sw.Port</th> </tr> </thead> <tbody> <tr> <td>2.75</td> <td>10.00</td> <td>Yes</td> <td></td> <td></td> </tr> <tr> <th>Inlet</th> <th>Outlet</th> <th>Moist. Ind.</th> <th>HPRelief</th> <th>Gauge Port</th> </tr> <tr> <td>3/8" MIOR</td> <td>3/8" MIOR</td> <td></td> <td></td> <td>Yes/Yes</td> </tr> </tbody> </table> | Diam. | Height | Sight Glass | Fuse Plug | Sw.Port | 2.75 | 10.00 | Yes | | | Inlet | Outlet | Moist. Ind. | HPRelief | Gauge Port | 3/8" MIOR | 3/8" MIOR | | | Yes/Yes |
|--|-------------|-------------|-------------|------------|---------|------|-------|-----|-----|-----|-------|--------|-------------|----------|------------|-----------|-----------|--|-----|--|---|-------|--------|-------------|-----------|---------|------|-------|-----|-----|-----|-------|--------|-------------|----------|------------|-------------|-------------|--|-----|-----|---|-------|--------|-------------|-----------|---------|------|-------|-----|-----|-----|-------|--------|-------------|----------|------------|-----------|-----------|--|-----|---------|
| Diam. | Height | Sight Glass | Fuse Plug | Sw.Port | | | | | | | | | | | | | | | | | | | | | | | | | | | | | | | | | | | | | | | | | | | | | | | | | | | | | | | | | | |
| 2.75 | 10.00 | | | | | | | | | | | | | | | | | | | | | | | | | | | | | | | | | | | | | | | | | | | | | | | | | | | | | | | | | | | | | |
| Inlet | Outlet | Moist. Ind. | HPRelief | Gauge Port | | | | | | | | | | | | | | | | | | | | | | | | | | | | | | | | | | | | | | | | | | | | | | | | | | | | | | | | | | |
| 3/8" MIOR | 3/8" MIOR | | | | | | | | | | | | | | | | | | | | | | | | | | | | | | | | | | | | | | | | | | | | | | | | | | | | | | | | | | | | | |
| Diam. | Height | Sight Glass | Fuse Plug | Sw.Port | | | | | | | | | | | | | | | | | | | | | | | | | | | | | | | | | | | | | | | | | | | | | | | | | | | | | | | | | | |
| 2.75 | 10.00 | | | | | | | | | | | | | | | | | | | | | | | | | | | | | | | | | | | | | | | | | | | | | | | | | | | | | | | | | | | | | |
| Inlet | Outlet | Moist. Ind. | HPRelief | Gauge Port | | | | | | | | | | | | | | | | | | | | | | | | | | | | | | | | | | | | | | | | | | | | | | | | | | | | | | | | | | |
| 3/8" MIOR | 3/8" MIOR | | | | | | | | | | | | | | | | | | | | | | | | | | | | | | | | | | | | | | | | | | | | | | | | | | | | | | | | | | | | | |
| Diam. | Height | Sight Glass | Fuse Plug | Sw.Port | | | | | | | | | | | | | | | | | | | | | | | | | | | | | | | | | | | | | | | | | | | | | | | | | | | | | | | | | | |
| 2.75 | 10.00 | Yes | | | | | | | | | | | | | | | | | | | | | | | | | | | | | | | | | | | | | | | | | | | | | | | | | | | | | | | | | | | | |
| Inlet | Outlet | Moist. Ind. | HPRelief | Gauge Port | | | | | | | | | | | | | | | | | | | | | | | | | | | | | | | | | | | | | | | | | | | | | | | | | | | | | | | | | | |
| 3/8" MIOR | 3/8" MIOR | | | Yes/Yes | | | | | | | | | | | | | | | | | | | | | | | | | | | | | | | | | | | | | | | | | | | | | | | | | | | | | | | | | | |
| <p>407466</p>  <table border="1"> <thead> <tr> <th>Diam.</th> <th>Height</th> <th>Sight Glass</th> <th>Fuse Plug</th> <th>Sw.Port</th> </tr> </thead> <tbody> <tr> <td>2.75</td> <td>10.00</td> <td>Yes</td> <td>Yes</td> <td>Yes</td> </tr> <tr> <th>Inlet</th> <th>Outlet</th> <th>Moist. Ind.</th> <th>HPRelief</th> <th>Gauge Port</th> </tr> <tr> <td>3/8" MIOR</td> <td>3/8" MIOR</td> <td></td> <td></td> <td></td> </tr> </tbody> </table> | Diam. | Height | Sight Glass | Fuse Plug | Sw.Port | 2.75 | 10.00 | Yes | Yes | Yes | Inlet | Outlet | Moist. Ind. | HPRelief | Gauge Port | 3/8" MIOR | 3/8" MIOR | | | | <p>407479</p>  <table border="1"> <thead> <tr> <th>Diam.</th> <th>Height</th> <th>Sight Glass</th> <th>Fuse Plug</th> <th>Sw.Port</th> </tr> </thead> <tbody> <tr> <td>3.00</td> <td>10.00</td> <td>Yes</td> <td>Yes</td> <td></td> </tr> <tr> <th>Inlet</th> <th>Outlet</th> <th>Moist. Ind.</th> <th>HPRelief</th> <th>Gauge Port</th> </tr> <tr> <td>QUICK DISC.</td> <td>QUICK DISC.</td> <td></td> <td>Yes</td> <td>Yes</td> </tr> </tbody> </table> | Diam. | Height | Sight Glass | Fuse Plug | Sw.Port | 3.00 | 10.00 | Yes | Yes | | Inlet | Outlet | Moist. Ind. | HPRelief | Gauge Port | QUICK DISC. | QUICK DISC. | | Yes | Yes | <p>407482</p>  <table border="1"> <thead> <tr> <th>Diam.</th> <th>Height</th> <th>Sight Glass</th> <th>Fuse Plug</th> <th>Sw.Port</th> </tr> </thead> <tbody> <tr> <td>3.00</td> <td>9.50</td> <td>Yes</td> <td>Yes</td> <td></td> </tr> <tr> <th>Inlet</th> <th>Outlet</th> <th>Moist. Ind.</th> <th>HPRelief</th> <th>Gauge Port</th> </tr> <tr> <td>3/8" MFL</td> <td>3/8" MFL</td> <td></td> <td></td> <td></td> </tr> </tbody> </table> | Diam. | Height | Sight Glass | Fuse Plug | Sw.Port | 3.00 | 9.50 | Yes | Yes | | Inlet | Outlet | Moist. Ind. | HPRelief | Gauge Port | 3/8" MFL | 3/8" MFL | | | |
| Diam. | Height | Sight Glass | Fuse Plug | Sw.Port | | | | | | | | | | | | | | | | | | | | | | | | | | | | | | | | | | | | | | | | | | | | | | | | | | | | | | | | | | |
| 2.75 | 10.00 | Yes | Yes | Yes | | | | | | | | | | | | | | | | | | | | | | | | | | | | | | | | | | | | | | | | | | | | | | | | | | | | | | | | | | |
| Inlet | Outlet | Moist. Ind. | HPRelief | Gauge Port | | | | | | | | | | | | | | | | | | | | | | | | | | | | | | | | | | | | | | | | | | | | | | | | | | | | | | | | | | |
| 3/8" MIOR | 3/8" MIOR | | | | | | | | | | | | | | | | | | | | | | | | | | | | | | | | | | | | | | | | | | | | | | | | | | | | | | | | | | | | | |
| Diam. | Height | Sight Glass | Fuse Plug | Sw.Port | | | | | | | | | | | | | | | | | | | | | | | | | | | | | | | | | | | | | | | | | | | | | | | | | | | | | | | | | | |
| 3.00 | 10.00 | Yes | Yes | | | | | | | | | | | | | | | | | | | | | | | | | | | | | | | | | | | | | | | | | | | | | | | | | | | | | | | | | | | |
| Inlet | Outlet | Moist. Ind. | HPRelief | Gauge Port | | | | | | | | | | | | | | | | | | | | | | | | | | | | | | | | | | | | | | | | | | | | | | | | | | | | | | | | | | |
| QUICK DISC. | QUICK DISC. | | Yes | Yes | | | | | | | | | | | | | | | | | | | | | | | | | | | | | | | | | | | | | | | | | | | | | | | | | | | | | | | | | | |
| Diam. | Height | Sight Glass | Fuse Plug | Sw.Port | | | | | | | | | | | | | | | | | | | | | | | | | | | | | | | | | | | | | | | | | | | | | | | | | | | | | | | | | | |
| 3.00 | 9.50 | Yes | Yes | | | | | | | | | | | | | | | | | | | | | | | | | | | | | | | | | | | | | | | | | | | | | | | | | | | | | | | | | | | |
| Inlet | Outlet | Moist. Ind. | HPRelief | Gauge Port | | | | | | | | | | | | | | | | | | | | | | | | | | | | | | | | | | | | | | | | | | | | | | | | | | | | | | | | | | |
| 3/8" MFL | 3/8" MFL | | | | | | | | | | | | | | | | | | | | | | | | | | | | | | | | | | | | | | | | | | | | | | | | | | | | | | | | | | | | | |
| <p>407485</p> <p style="text-align: center;">PICTURE NOT AVAILABLE</p> <p>LIEBHERR 56 13 776</p> <table border="1"> <thead> <tr> <th>Diam.</th> <th>Height</th> <th>Sight Glass</th> <th>Fuse Plug</th> <th>Sw.Port</th> </tr> </thead> <tbody> <tr> <td>4.00</td> <td>7.75</td> <td>Yes</td> <td></td> <td></td> </tr> <tr> <th>Inlet</th> <th>Outlet</th> <th>Moist. Ind.</th> <th>HPRelief</th> <th>Gauge Port</th> </tr> <tr> <td>3/8" FOR</td> <td>3/8" MIOR</td> <td></td> <td></td> <td></td> </tr> </tbody> </table> | Diam. | Height | Sight Glass | Fuse Plug | Sw.Port | 4.00 | 7.75 | Yes | | | Inlet | Outlet | Moist. Ind. | HPRelief | Gauge Port | 3/8" FOR | 3/8" MIOR | | | | <p>407489</p>  <table border="1"> <thead> <tr> <th>Diam.</th> <th>Height</th> <th>Sight Glass</th> <th>Fuse Plug</th> <th>Sw.Port</th> </tr> </thead> <tbody> <tr> <td>3.00</td> <td>10.10</td> <td></td> <td></td> <td>Yes</td> </tr> <tr> <th>Inlet</th> <th>Outlet</th> <th>Moist. Ind.</th> <th>HPRelief</th> <th>Gauge Port</th> </tr> <tr> <td>QUICK DISC.</td> <td>QUICK DISC.</td> <td></td> <td>Yes</td> <td>Yes</td> </tr> </tbody> </table> | Diam. | Height | Sight Glass | Fuse Plug | Sw.Port | 3.00 | 10.10 | | | Yes | Inlet | Outlet | Moist. Ind. | HPRelief | Gauge Port | QUICK DISC. | QUICK DISC. | | Yes | Yes | <p>407495</p>  <table border="1"> <thead> <tr> <th>Diam.</th> <th>Height</th> <th>Sight Glass</th> <th>Fuse Plug</th> <th>Sw.Port</th> </tr> </thead> <tbody> <tr> <td>3.00</td> <td>8.25</td> <td>Yes</td> <td>Yes</td> <td>Yes</td> </tr> <tr> <th>Inlet</th> <th>Outlet</th> <th>Moist. Ind.</th> <th>HPRelief</th> <th>Gauge Port</th> </tr> <tr> <td>3/8" MIOR</td> <td>3/8" FOR</td> <td></td> <td>Yes</td> <td>Yes</td> </tr> </tbody> </table> | Diam. | Height | Sight Glass | Fuse Plug | Sw.Port | 3.00 | 8.25 | Yes | Yes | Yes | Inlet | Outlet | Moist. Ind. | HPRelief | Gauge Port | 3/8" MIOR | 3/8" FOR | | Yes | Yes |
| Diam. | Height | Sight Glass | Fuse Plug | Sw.Port | | | | | | | | | | | | | | | | | | | | | | | | | | | | | | | | | | | | | | | | | | | | | | | | | | | | | | | | | | |
| 4.00 | 7.75 | Yes | | | | | | | | | | | | | | | | | | | | | | | | | | | | | | | | | | | | | | | | | | | | | | | | | | | | | | | | | | | | |
| Inlet | Outlet | Moist. Ind. | HPRelief | Gauge Port | | | | | | | | | | | | | | | | | | | | | | | | | | | | | | | | | | | | | | | | | | | | | | | | | | | | | | | | | | |
| 3/8" FOR | 3/8" MIOR | | | | | | | | | | | | | | | | | | | | | | | | | | | | | | | | | | | | | | | | | | | | | | | | | | | | | | | | | | | | | |
| Diam. | Height | Sight Glass | Fuse Plug | Sw.Port | | | | | | | | | | | | | | | | | | | | | | | | | | | | | | | | | | | | | | | | | | | | | | | | | | | | | | | | | | |
| 3.00 | 10.10 | | | Yes | | | | | | | | | | | | | | | | | | | | | | | | | | | | | | | | | | | | | | | | | | | | | | | | | | | | | | | | | | |
| Inlet | Outlet | Moist. Ind. | HPRelief | Gauge Port | | | | | | | | | | | | | | | | | | | | | | | | | | | | | | | | | | | | | | | | | | | | | | | | | | | | | | | | | | |
| QUICK DISC. | QUICK DISC. | | Yes | Yes | | | | | | | | | | | | | | | | | | | | | | | | | | | | | | | | | | | | | | | | | | | | | | | | | | | | | | | | | | |
| Diam. | Height | Sight Glass | Fuse Plug | Sw.Port | | | | | | | | | | | | | | | | | | | | | | | | | | | | | | | | | | | | | | | | | | | | | | | | | | | | | | | | | | |
| 3.00 | 8.25 | Yes | Yes | Yes | | | | | | | | | | | | | | | | | | | | | | | | | | | | | | | | | | | | | | | | | | | | | | | | | | | | | | | | | | |
| Inlet | Outlet | Moist. Ind. | HPRelief | Gauge Port | | | | | | | | | | | | | | | | | | | | | | | | | | | | | | | | | | | | | | | | | | | | | | | | | | | | | | | | | | |
| 3/8" MIOR | 3/8" FOR | | Yes | Yes | | | | | | | | | | | | | | | | | | | | | | | | | | | | | | | | | | | | | | | | | | | | | | | | | | | | | | | | | | |
| <p>407524</p>  <table border="1"> <thead> <tr> <th>Diam.</th> <th>Height</th> <th>Sight Glass</th> <th>Fuse Plug</th> <th>Sw.Port</th> </tr> </thead> <tbody> <tr> <td>3.00</td> <td>8.25</td> <td></td> <td>Yes</td> <td>Yes</td> </tr> <tr> <th>Inlet</th> <th>Outlet</th> <th>Moist. Ind.</th> <th>HPRelief</th> <th>Gauge Port</th> </tr> <tr> <td>3/8" MIOR</td> <td>3/8" MIOR</td> <td></td> <td>Yes</td> <td></td> </tr> </tbody> </table> | Diam. | Height | Sight Glass | Fuse Plug | Sw.Port | 3.00 | 8.25 | | Yes | Yes | Inlet | Outlet | Moist. Ind. | HPRelief | Gauge Port | 3/8" MIOR | 3/8" MIOR | | Yes | | <p>407527</p> <p style="text-align: center;">PICTURE NOT AVAILABLE</p> <table border="1"> <thead> <tr> <th>Diam.</th> <th>Height</th> <th>Sight Glass</th> <th>Fuse Plug</th> <th>Sw.Port</th> </tr> </thead> <tbody> <tr> <td>3.00</td> <td>8.25</td> <td></td> <td>Yes</td> <td>Yes</td> </tr> <tr> <th>Inlet</th> <th>Outlet</th> <th>Moist. Ind.</th> <th>HPRelief</th> <th>Gauge Port</th> </tr> <tr> <td>3/8" MIOR</td> <td>3/8" MIOR</td> <td></td> <td>Yes</td> <td></td> </tr> </tbody> </table> | Diam. | Height | Sight Glass | Fuse Plug | Sw.Port | 3.00 | 8.25 | | Yes | Yes | Inlet | Outlet | Moist. Ind. | HPRelief | Gauge Port | 3/8" MIOR | 3/8" MIOR | | Yes | | <p>407541</p>  <table border="1"> <thead> <tr> <th>Diam.</th> <th>Height</th> <th>Sight Glass</th> <th>Fuse Plug</th> <th>Sw.Port</th> </tr> </thead> <tbody> <tr> <td>3.00</td> <td>8.25</td> <td></td> <td>Yes</td> <td>Yes</td> </tr> <tr> <th>Inlet</th> <th>Outlet</th> <th>Moist. Ind.</th> <th>HPRelief</th> <th>Gauge Port</th> </tr> <tr> <td>3/8" MIOR</td> <td>3/8" MIOR</td> <td></td> <td>Yes</td> <td></td> </tr> </tbody> </table> | Diam. | Height | Sight Glass | Fuse Plug | Sw.Port | 3.00 | 8.25 | | Yes | Yes | Inlet | Outlet | Moist. Ind. | HPRelief | Gauge Port | 3/8" MIOR | 3/8" MIOR | | Yes | |
| Diam. | Height | Sight Glass | Fuse Plug | Sw.Port | | | | | | | | | | | | | | | | | | | | | | | | | | | | | | | | | | | | | | | | | | | | | | | | | | | | | | | | | | |
| 3.00 | 8.25 | | Yes | Yes | | | | | | | | | | | | | | | | | | | | | | | | | | | | | | | | | | | | | | | | | | | | | | | | | | | | | | | | | | |
| Inlet | Outlet | Moist. Ind. | HPRelief | Gauge Port | | | | | | | | | | | | | | | | | | | | | | | | | | | | | | | | | | | | | | | | | | | | | | | | | | | | | | | | | | |
| 3/8" MIOR | 3/8" MIOR | | Yes | | | | | | | | | | | | | | | | | | | | | | | | | | | | | | | | | | | | | | | | | | | | | | | | | | | | | | | | | | | |
| Diam. | Height | Sight Glass | Fuse Plug | Sw.Port | | | | | | | | | | | | | | | | | | | | | | | | | | | | | | | | | | | | | | | | | | | | | | | | | | | | | | | | | | |
| 3.00 | 8.25 | | Yes | Yes | | | | | | | | | | | | | | | | | | | | | | | | | | | | | | | | | | | | | | | | | | | | | | | | | | | | | | | | | | |
| Inlet | Outlet | Moist. Ind. | HPRelief | Gauge Port | | | | | | | | | | | | | | | | | | | | | | | | | | | | | | | | | | | | | | | | | | | | | | | | | | | | | | | | | | |
| 3/8" MIOR | 3/8" MIOR | | Yes | | | | | | | | | | | | | | | | | | | | | | | | | | | | | | | | | | | | | | | | | | | | | | | | | | | | | | | | | | | |
| Diam. | Height | Sight Glass | Fuse Plug | Sw.Port | | | | | | | | | | | | | | | | | | | | | | | | | | | | | | | | | | | | | | | | | | | | | | | | | | | | | | | | | | |
| 3.00 | 8.25 | | Yes | Yes | | | | | | | | | | | | | | | | | | | | | | | | | | | | | | | | | | | | | | | | | | | | | | | | | | | | | | | | | | |
| Inlet | Outlet | Moist. Ind. | HPRelief | Gauge Port | | | | | | | | | | | | | | | | | | | | | | | | | | | | | | | | | | | | | | | | | | | | | | | | | | | | | | | | | | |
| 3/8" MIOR | 3/8" MIOR | | Yes | | | | | | | | | | | | | | | | | | | | | | | | | | | | | | | | | | | | | | | | | | | | | | | | | | | | | | | | | | | |

| 407578 | |  | | 407647 | |  | | | |
|----------|----------|---|-----------|------------|--------------------|---|-------------|-----------|------------|
| Diam. | Height | Sight Glass | Fuse Plug | Sw.Port | Diam. | Height | Sight Glass | Fuse Plug | Sw.Port |
| 4.00 | 8.00 | Yes | Yes | | 4.00 | 9.00 | Yes | | |
| Inlet | Outlet | Moist. Ind. | HPRelief | Gauge Port | Inlet | Outlet | Moist. Ind. | HPRelief | Gauge Port |
| 3/8" MFL | 3/8" MFL | | | | 3/8" FOR 3/8" MIOR | | | | |

DRIERS

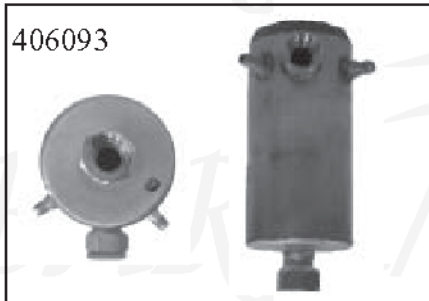

406093

| Diam. | Height | Sight Glass | Fuse Plug | Sw.Port |
|---------------|--------|-------------|-----------|------------|
| 3.50 | 8.00 | | | 2 |
| Inlet | Outlet | Moist. Ind. | HPRelief | Gauge Port |
| 3/4" FOR 3/4" | FOR | | | |

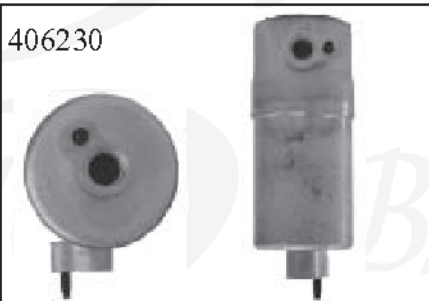

406230

| Diam. | Height | Sight Glass | Fuse Plug | Sw.Port |
|---------------|---------------|-------------|-----------|------------|
| 3.50 | 8.00 | | | |
| Inlet | Outlet | Moist. Ind. | HPRelief | Gauge Port |
| PAD-PETERBILT | PAD-PETERBILT | | | |

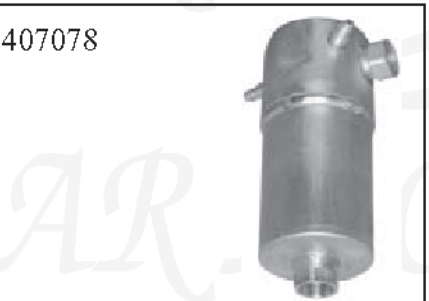

407078

| Diam. | Height | Sight Glass | Fuse Plug | Sw.Port |
|---------------|--------|-------------|-----------|------------|
| 3.00 | 8.50 | | | 2 |
| Inlet | Outlet | Moist. Ind. | HPRelief | Gauge Port |
| 3/4" FOR 3/4" | MIOR | | | |



407079

| Diam. | Height | Sight Glass | Fuse Plug | Sw.Port |
|---------------|--------|-------------|-----------|------------|
| 3.50 | 9.50 | | | Yes |
| Inlet | Outlet | Moist. Ind. | HPRelief | Gauge Port |
| 3/4" FOR 3/4" | MIOR | | | |



407080

| Diam. | Height | Sight Glass | Fuse Plug | Sw.Port |
|---------------|--------|-------------|-----------|------------|
| 3.50 | 9.50 | | | 2 |
| Inlet | Outlet | Moist. Ind. | HPRelief | Gauge Port |
| 3/4" FOR 3/4" | MIOR | | | |



407081

| Diam. | Height | Sight Glass | Fuse Plug | Sw.Port |
|---------------|--------|-------------|-----------|------------|
| 3.50 | 9.50 | | | Yes |
| Inlet | Outlet | Moist. Ind. | HPRelief | Gauge Port |
| 3/4" FOR 3/4" | MIOR | | | |



407082

| Diam. | Height | Sight Glass | Fuse Plug | Sw.Port |
|---------------|--------|-------------|-----------|------------|
| 3.50 | 9.50 | | | |
| Inlet | Outlet | Moist. Ind. | HPRelief | Gauge Port |
| 3/4" FOR 3/4" | MIOR | | | |



407083

| Diam. | Height | Sight Glass | Fuse Plug | Sw.Port |
|---------------|--------|-------------|-----------|------------|
| 3.50 | 9.50 | | | Yes |
| Inlet | Outlet | Moist. Ind. | HPRelief | Gauge Port |
| 3/4" FOR 3/4" | MIOR | | | |



407084

| Diam. | Height | Sight Glass | Fuse Plug | Sw.Port |
|---------------|--------|-------------|-----------|------------|
| 3.50 | 9.50 | | | 2 |
| Inlet | Outlet | Moist. Ind. | HPRelief | Gauge Port |
| 3/4" FOR 3/4" | MIOR | | | |



407085

| Diam. | Height | Sight Glass | Fuse Plug | Sw.Port |
|---------------|--------|-------------|-----------|------------|
| 3.50 | 9.50 | | | 2 |
| Inlet | Outlet | Moist. Ind. | HPRelief | Gauge Port |
| 3/4" FOR 3/4" | MIOR | | | |



407086

| Diam. | Height | Sight Glass | Fuse Plug | Sw.Port |
|---------------|--------|-------------|-----------|------------|
| 3.50 | 9.50 | | | 2 |
| Inlet | Outlet | Moist. Ind. | HPRelief | Gauge Port |
| 3/4" FOR 3/4" | MIOR | | | |



407087

| Diam. | Height | Sight Glass | Fuse Plug | Sw.Port |
|---------------|--------|-------------|-----------|------------|
| 3.50 | 9.50 | | | 2 |
| Inlet | Outlet | Moist. Ind. | HPRelief | Gauge Port |
| 3/4" FOR 3/4" | MIOR | | | |

| <p>407088</p>  <table border="1"> <thead> <tr> <th>Diam.</th> <th>Height</th> <th>Sight Glass</th> <th>Fuse Plug</th> <th>Sw.Port.</th> </tr> </thead> <tbody> <tr> <td>3.50</td> <td>9.50</td> <td></td> <td></td> <td>Yes</td> </tr> <tr> <th>Inlet</th> <th>Outlet</th> <th>Moist. Ind.</th> <th>HPRelief</th> <th>Gauge Port.</th> </tr> <tr> <td>3/4" FOR 3/4" MIOR</td> <td></td> <td></td> <td></td> <td></td> </tr> </tbody> </table> | Diam. | Height | Sight Glass | Fuse Plug | Sw.Port. | 3.50 | 9.50 | | | Yes | Inlet | Outlet | Moist. Ind. | HPRelief | Gauge Port. | 3/4" FOR 3/4" MIOR | | | | | <p>407089</p>  <table border="1"> <thead> <tr> <th>Diam.</th> <th>Height</th> <th>Sight Glass</th> <th>Fuse Plug</th> <th>Sw.Port.</th> </tr> </thead> <tbody> <tr> <td>3.50</td> <td>9.00</td> <td></td> <td></td> <td>Yes</td> </tr> <tr> <th>Inlet</th> <th>Outlet</th> <th>Moist. Ind.</th> <th>HPRelief</th> <th>Gauge Port.</th> </tr> <tr> <td>M27 FOR M27 MOR</td> <td></td> <td></td> <td></td> <td></td> </tr> </tbody> </table> | Diam. | Height | Sight Glass | Fuse Plug | Sw.Port. | 3.50 | 9.00 | | | Yes | Inlet | Outlet | Moist. Ind. | HPRelief | Gauge Port. | M27 FOR M27 MOR | | | | | <p>407090</p>  <table border="1"> <thead> <tr> <th>Diam.</th> <th>Height</th> <th>Sight Glass</th> <th>Fuse Plug</th> <th>Sw.Port.</th> </tr> </thead> <tbody> <tr> <td>3.50</td> <td>9.50</td> <td></td> <td></td> <td>2</td> </tr> <tr> <th>Inlet</th> <th>Outlet</th> <th>Moist. Ind.</th> <th>HPRelief</th> <th>Gauge Port.</th> </tr> <tr> <td>3/4" FOR 3/4" MIOR</td> <td></td> <td></td> <td></td> <td></td> </tr> </tbody> </table> | Diam. | Height | Sight Glass | Fuse Plug | Sw.Port. | 3.50 | 9.50 | | | 2 | Inlet | Outlet | Moist. Ind. | HPRelief | Gauge Port. | 3/4" FOR 3/4" MIOR | | | | |
|---|--------|-------------|-------------|-------------|----------|------|-------|--|--|-----|-------|--------|-------------|----------|-------------|-------------------------|--|--|-----|--|---|-------|--------|-------------|-----------|----------|------|-------|--|--|-----|-------|--------|-------------|----------|-------------|-------------------------|--|--|--|--|--|-------|--------|-------------|-----------|----------|------|-------|--|--|---|-------|--------|-------------|----------|-------------|-------------------------|--|--|--|--|
| Diam. | Height | Sight Glass | Fuse Plug | Sw.Port. | | | | | | | | | | | | | | | | | | | | | | | | | | | | | | | | | | | | | | | | | | | | | | | | | | | | | | | | | | |
| 3.50 | 9.50 | | | Yes | | | | | | | | | | | | | | | | | | | | | | | | | | | | | | | | | | | | | | | | | | | | | | | | | | | | | | | | | | |
| Inlet | Outlet | Moist. Ind. | HPRelief | Gauge Port. | | | | | | | | | | | | | | | | | | | | | | | | | | | | | | | | | | | | | | | | | | | | | | | | | | | | | | | | | | |
| 3/4" FOR 3/4" MIOR | | | | | | | | | | | | | | | | | | | | | | | | | | | | | | | | | | | | | | | | | | | | | | | | | | | | | | | | | | | | | | |
| Diam. | Height | Sight Glass | Fuse Plug | Sw.Port. | | | | | | | | | | | | | | | | | | | | | | | | | | | | | | | | | | | | | | | | | | | | | | | | | | | | | | | | | | |
| 3.50 | 9.00 | | | Yes | | | | | | | | | | | | | | | | | | | | | | | | | | | | | | | | | | | | | | | | | | | | | | | | | | | | | | | | | | |
| Inlet | Outlet | Moist. Ind. | HPRelief | Gauge Port. | | | | | | | | | | | | | | | | | | | | | | | | | | | | | | | | | | | | | | | | | | | | | | | | | | | | | | | | | | |
| M27 FOR M27 MOR | | | | | | | | | | | | | | | | | | | | | | | | | | | | | | | | | | | | | | | | | | | | | | | | | | | | | | | | | | | | | | |
| Diam. | Height | Sight Glass | Fuse Plug | Sw.Port. | | | | | | | | | | | | | | | | | | | | | | | | | | | | | | | | | | | | | | | | | | | | | | | | | | | | | | | | | | |
| 3.50 | 9.50 | | | 2 | | | | | | | | | | | | | | | | | | | | | | | | | | | | | | | | | | | | | | | | | | | | | | | | | | | | | | | | | | |
| Inlet | Outlet | Moist. Ind. | HPRelief | Gauge Port. | | | | | | | | | | | | | | | | | | | | | | | | | | | | | | | | | | | | | | | | | | | | | | | | | | | | | | | | | | |
| 3/4" FOR 3/4" MIOR | | | | | | | | | | | | | | | | | | | | | | | | | | | | | | | | | | | | | | | | | | | | | | | | | | | | | | | | | | | | | | |
| <p>407091</p>  <table border="1"> <thead> <tr> <th>Diam.</th> <th>Height</th> <th>Sight Glass</th> <th>Fuse Plug</th> <th>Sw.Port.</th> </tr> </thead> <tbody> <tr> <td>3.50</td> <td>9.00</td> <td></td> <td></td> <td>2</td> </tr> <tr> <th>Inlet</th> <th>Outlet</th> <th>Moist. Ind.</th> <th>HPRelief</th> <th>Gauge Port.</th> </tr> <tr> <td>3/4" FOR 3/4" MIOR</td> <td></td> <td></td> <td></td> <td></td> </tr> </tbody> </table> | Diam. | Height | Sight Glass | Fuse Plug | Sw.Port. | 3.50 | 9.00 | | | 2 | Inlet | Outlet | Moist. Ind. | HPRelief | Gauge Port. | 3/4" FOR 3/4" MIOR | | | | | <p>407092</p>  <table border="1"> <thead> <tr> <th>Diam.</th> <th>Height</th> <th>Sight Glass</th> <th>Fuse Plug</th> <th>Sw.Port.</th> </tr> </thead> <tbody> <tr> <td>3.50</td> <td>10.00</td> <td></td> <td></td> <td>Yes</td> </tr> <tr> <th>Inlet</th> <th>Outlet</th> <th>Moist. Ind.</th> <th>HPRelief</th> <th>Gauge Port.</th> </tr> <tr> <td>3/4" FOR 3/4" MIOR</td> <td></td> <td></td> <td></td> <td></td> </tr> </tbody> </table> | Diam. | Height | Sight Glass | Fuse Plug | Sw.Port. | 3.50 | 10.00 | | | Yes | Inlet | Outlet | Moist. Ind. | HPRelief | Gauge Port. | 3/4" FOR 3/4" MIOR | | | | | <p>407093</p>  <table border="1"> <thead> <tr> <th>Diam.</th> <th>Height</th> <th>Sight Glass</th> <th>Fuse Plug</th> <th>Sw.Port.</th> </tr> </thead> <tbody> <tr> <td>3.50</td> <td>10.00</td> <td></td> <td></td> <td>2</td> </tr> <tr> <th>Inlet</th> <th>Outlet</th> <th>Moist. Ind.</th> <th>HPRelief</th> <th>Gauge Port.</th> </tr> <tr> <td>5/8" MOR 5/8" MOR</td> <td></td> <td></td> <td></td> <td></td> </tr> </tbody> </table> | Diam. | Height | Sight Glass | Fuse Plug | Sw.Port. | 3.50 | 10.00 | | | 2 | Inlet | Outlet | Moist. Ind. | HPRelief | Gauge Port. | 5/8" MOR 5/8" MOR | | | | |
| Diam. | Height | Sight Glass | Fuse Plug | Sw.Port. | | | | | | | | | | | | | | | | | | | | | | | | | | | | | | | | | | | | | | | | | | | | | | | | | | | | | | | | | | |
| 3.50 | 9.00 | | | 2 | | | | | | | | | | | | | | | | | | | | | | | | | | | | | | | | | | | | | | | | | | | | | | | | | | | | | | | | | | |
| Inlet | Outlet | Moist. Ind. | HPRelief | Gauge Port. | | | | | | | | | | | | | | | | | | | | | | | | | | | | | | | | | | | | | | | | | | | | | | | | | | | | | | | | | | |
| 3/4" FOR 3/4" MIOR | | | | | | | | | | | | | | | | | | | | | | | | | | | | | | | | | | | | | | | | | | | | | | | | | | | | | | | | | | | | | | |
| Diam. | Height | Sight Glass | Fuse Plug | Sw.Port. | | | | | | | | | | | | | | | | | | | | | | | | | | | | | | | | | | | | | | | | | | | | | | | | | | | | | | | | | | |
| 3.50 | 10.00 | | | Yes | | | | | | | | | | | | | | | | | | | | | | | | | | | | | | | | | | | | | | | | | | | | | | | | | | | | | | | | | | |
| Inlet | Outlet | Moist. Ind. | HPRelief | Gauge Port. | | | | | | | | | | | | | | | | | | | | | | | | | | | | | | | | | | | | | | | | | | | | | | | | | | | | | | | | | | |
| 3/4" FOR 3/4" MIOR | | | | | | | | | | | | | | | | | | | | | | | | | | | | | | | | | | | | | | | | | | | | | | | | | | | | | | | | | | | | | | |
| Diam. | Height | Sight Glass | Fuse Plug | Sw.Port. | | | | | | | | | | | | | | | | | | | | | | | | | | | | | | | | | | | | | | | | | | | | | | | | | | | | | | | | | | |
| 3.50 | 10.00 | | | 2 | | | | | | | | | | | | | | | | | | | | | | | | | | | | | | | | | | | | | | | | | | | | | | | | | | | | | | | | | | |
| Inlet | Outlet | Moist. Ind. | HPRelief | Gauge Port. | | | | | | | | | | | | | | | | | | | | | | | | | | | | | | | | | | | | | | | | | | | | | | | | | | | | | | | | | | |
| 5/8" MOR 5/8" MOR | | | | | | | | | | | | | | | | | | | | | | | | | | | | | | | | | | | | | | | | | | | | | | | | | | | | | | | | | | | | | | |
| <p>407094</p>  <table border="1"> <thead> <tr> <th>Diam.</th> <th>Height</th> <th>Sight Glass</th> <th>Fuse Plug</th> <th>Sw.Port.</th> </tr> </thead> <tbody> <tr> <td>3.50</td> <td>10.00</td> <td></td> <td></td> <td>2</td> </tr> <tr> <th>Inlet</th> <th>Outlet</th> <th>Moist. Ind.</th> <th>HPRelief</th> <th>Gauge Port.</th> </tr> <tr> <td>5/8" MOR 5/8" MOR</td> <td></td> <td></td> <td></td> <td></td> </tr> </tbody> </table> | Diam. | Height | Sight Glass | Fuse Plug | Sw.Port. | 3.50 | 10.00 | | | 2 | Inlet | Outlet | Moist. Ind. | HPRelief | Gauge Port. | 5/8" MOR 5/8" MOR | | | | | <p>407095</p>  <table border="1"> <thead> <tr> <th>Diam.</th> <th>Height</th> <th>Sight Glass</th> <th>Fuse Plug</th> <th>Sw.Port.</th> </tr> </thead> <tbody> <tr> <td>3.50</td> <td>12.00</td> <td></td> <td></td> <td>Yes</td> </tr> <tr> <th>Inlet</th> <th>Outlet</th> <th>Moist. Ind.</th> <th>HPRelief</th> <th>Gauge Port.</th> </tr> <tr> <td>3/4" MSPRLK 3/4" MSPRLK</td> <td></td> <td></td> <td></td> <td></td> </tr> </tbody> </table> | Diam. | Height | Sight Glass | Fuse Plug | Sw.Port. | 3.50 | 12.00 | | | Yes | Inlet | Outlet | Moist. Ind. | HPRelief | Gauge Port. | 3/4" MSPRLK 3/4" MSPRLK | | | | | <p>407096</p>  <table border="1"> <thead> <tr> <th>Diam.</th> <th>Height</th> <th>Sight Glass</th> <th>Fuse Plug</th> <th>Sw.Port.</th> </tr> </thead> <tbody> <tr> <td>3.50</td> <td>8.00</td> <td></td> <td></td> <td>2</td> </tr> <tr> <th>Inlet</th> <th>Outlet</th> <th>Moist. Ind.</th> <th>HPRelief</th> <th>Gauge Port.</th> </tr> <tr> <td>5/8" FSPRLK 5/8" FSPRLK</td> <td></td> <td></td> <td></td> <td></td> </tr> </tbody> </table> | Diam. | Height | Sight Glass | Fuse Plug | Sw.Port. | 3.50 | 8.00 | | | 2 | Inlet | Outlet | Moist. Ind. | HPRelief | Gauge Port. | 5/8" FSPRLK 5/8" FSPRLK | | | | |
| Diam. | Height | Sight Glass | Fuse Plug | Sw.Port. | | | | | | | | | | | | | | | | | | | | | | | | | | | | | | | | | | | | | | | | | | | | | | | | | | | | | | | | | | |
| 3.50 | 10.00 | | | 2 | | | | | | | | | | | | | | | | | | | | | | | | | | | | | | | | | | | | | | | | | | | | | | | | | | | | | | | | | | |
| Inlet | Outlet | Moist. Ind. | HPRelief | Gauge Port. | | | | | | | | | | | | | | | | | | | | | | | | | | | | | | | | | | | | | | | | | | | | | | | | | | | | | | | | | | |
| 5/8" MOR 5/8" MOR | | | | | | | | | | | | | | | | | | | | | | | | | | | | | | | | | | | | | | | | | | | | | | | | | | | | | | | | | | | | | | |
| Diam. | Height | Sight Glass | Fuse Plug | Sw.Port. | | | | | | | | | | | | | | | | | | | | | | | | | | | | | | | | | | | | | | | | | | | | | | | | | | | | | | | | | | |
| 3.50 | 12.00 | | | Yes | | | | | | | | | | | | | | | | | | | | | | | | | | | | | | | | | | | | | | | | | | | | | | | | | | | | | | | | | | |
| Inlet | Outlet | Moist. Ind. | HPRelief | Gauge Port. | | | | | | | | | | | | | | | | | | | | | | | | | | | | | | | | | | | | | | | | | | | | | | | | | | | | | | | | | | |
| 3/4" MSPRLK 3/4" MSPRLK | | | | | | | | | | | | | | | | | | | | | | | | | | | | | | | | | | | | | | | | | | | | | | | | | | | | | | | | | | | | | | |
| Diam. | Height | Sight Glass | Fuse Plug | Sw.Port. | | | | | | | | | | | | | | | | | | | | | | | | | | | | | | | | | | | | | | | | | | | | | | | | | | | | | | | | | | |
| 3.50 | 8.00 | | | 2 | | | | | | | | | | | | | | | | | | | | | | | | | | | | | | | | | | | | | | | | | | | | | | | | | | | | | | | | | | |
| Inlet | Outlet | Moist. Ind. | HPRelief | Gauge Port. | | | | | | | | | | | | | | | | | | | | | | | | | | | | | | | | | | | | | | | | | | | | | | | | | | | | | | | | | | |
| 5/8" FSPRLK 5/8" FSPRLK | | | | | | | | | | | | | | | | | | | | | | | | | | | | | | | | | | | | | | | | | | | | | | | | | | | | | | | | | | | | | | |
| <p>407097</p>  <table border="1"> <thead> <tr> <th>Diam.</th> <th>Height</th> <th>Sight Glass</th> <th>Fuse Plug</th> <th>Sw.Port.</th> </tr> </thead> <tbody> <tr> <td>3.50</td> <td>8.75</td> <td></td> <td></td> <td></td> </tr> <tr> <th>Inlet</th> <th>Outlet</th> <th>Moist. Ind.</th> <th>HPRelief</th> <th>Gauge Port.</th> </tr> <tr> <td>5/8" MSPRLK 5/8" MSPRLK</td> <td></td> <td></td> <td>Yes</td> <td></td> </tr> </tbody> </table> | Diam. | Height | Sight Glass | Fuse Plug | Sw.Port. | 3.50 | 8.75 | | | | Inlet | Outlet | Moist. Ind. | HPRelief | Gauge Port. | 5/8" MSPRLK 5/8" MSPRLK | | | Yes | | <p>407098</p>  <p>PR 18-03837</p> <table border="1"> <thead> <tr> <th>Diam.</th> <th>Height</th> <th>Sight Glass</th> <th>Fuse Plug</th> <th>Sw.Port.</th> </tr> </thead> <tbody> <tr> <td>3.75</td> <td>9.25</td> <td></td> <td></td> <td></td> </tr> <tr> <th>Inlet</th> <th>Outlet</th> <th>Moist. Ind.</th> <th>HPRelief</th> <th>Gauge Port.</th> </tr> <tr> <td>1-1/16" FOR 1-1/16" FOR</td> <td></td> <td></td> <td></td> <td></td> </tr> </tbody> </table> | Diam. | Height | Sight Glass | Fuse Plug | Sw.Port. | 3.75 | 9.25 | | | | Inlet | Outlet | Moist. Ind. | HPRelief | Gauge Port. | 1-1/16" FOR 1-1/16" FOR | | | | | <p>D706-514</p>  <p>CAT 151-5261</p> <table border="1"> <thead> <tr> <th>Diam.</th> <th>Height</th> <th>Sight Glass</th> <th>Fuse Plug</th> <th>Sw.Port.</th> </tr> </thead> <tbody> <tr> <td>3.50</td> <td>9.50</td> <td></td> <td></td> <td></td> </tr> <tr> <th>Inlet</th> <th>Outlet</th> <th>Moist. Ind.</th> <th>HPRelief</th> <th>Gauge Port.</th> </tr> <tr> <td>3/4" FOR 3/4" FOR</td> <td></td> <td></td> <td></td> <td></td> </tr> </tbody> </table> | Diam. | Height | Sight Glass | Fuse Plug | Sw.Port. | 3.50 | 9.50 | | | | Inlet | Outlet | Moist. Ind. | HPRelief | Gauge Port. | 3/4" FOR 3/4" FOR | | | | |
| Diam. | Height | Sight Glass | Fuse Plug | Sw.Port. | | | | | | | | | | | | | | | | | | | | | | | | | | | | | | | | | | | | | | | | | | | | | | | | | | | | | | | | | | |
| 3.50 | 8.75 | | | | | | | | | | | | | | | | | | | | | | | | | | | | | | | | | | | | | | | | | | | | | | | | | | | | | | | | | | | | | |
| Inlet | Outlet | Moist. Ind. | HPRelief | Gauge Port. | | | | | | | | | | | | | | | | | | | | | | | | | | | | | | | | | | | | | | | | | | | | | | | | | | | | | | | | | | |
| 5/8" MSPRLK 5/8" MSPRLK | | | Yes | | | | | | | | | | | | | | | | | | | | | | | | | | | | | | | | | | | | | | | | | | | | | | | | | | | | | | | | | | | |
| Diam. | Height | Sight Glass | Fuse Plug | Sw.Port. | | | | | | | | | | | | | | | | | | | | | | | | | | | | | | | | | | | | | | | | | | | | | | | | | | | | | | | | | | |
| 3.75 | 9.25 | | | | | | | | | | | | | | | | | | | | | | | | | | | | | | | | | | | | | | | | | | | | | | | | | | | | | | | | | | | | | |
| Inlet | Outlet | Moist. Ind. | HPRelief | Gauge Port. | | | | | | | | | | | | | | | | | | | | | | | | | | | | | | | | | | | | | | | | | | | | | | | | | | | | | | | | | | |
| 1-1/16" FOR 1-1/16" FOR | | | | | | | | | | | | | | | | | | | | | | | | | | | | | | | | | | | | | | | | | | | | | | | | | | | | | | | | | | | | | | |
| Diam. | Height | Sight Glass | Fuse Plug | Sw.Port. | | | | | | | | | | | | | | | | | | | | | | | | | | | | | | | | | | | | | | | | | | | | | | | | | | | | | | | | | | |
| 3.50 | 9.50 | | | | | | | | | | | | | | | | | | | | | | | | | | | | | | | | | | | | | | | | | | | | | | | | | | | | | | | | | | | | | |
| Inlet | Outlet | Moist. Ind. | HPRelief | Gauge Port. | | | | | | | | | | | | | | | | | | | | | | | | | | | | | | | | | | | | | | | | | | | | | | | | | | | | | | | | | | |
| 3/4" FOR 3/4" FOR | | | | | | | | | | | | | | | | | | | | | | | | | | | | | | | | | | | | | | | | | | | | | | | | | | | | | | | | | | | | | | |

MOISTURE INDICATORS

406568



MOISTURE INDICATOR
3/8 MIPOR X 3/8 MIPOR

406569

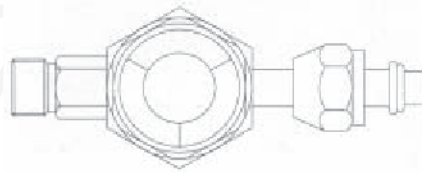

MOISTURE INDICATOR
3/8 FOR X 3/8 MIPOR

407514

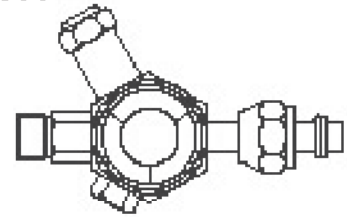

MOISTURE INDICATOR
3/8 FOR X 3/8 MIPOR,PRV,SW

407515

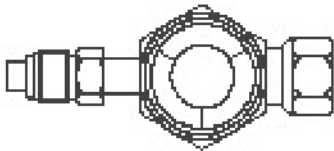

MOISTURE INDICATOR
3/8 MOR X 3/8 FIOR,SW

407516

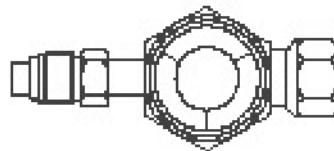

MOISTURE INDICATOR
3/8 FIOR X 3/8 MOR

407517

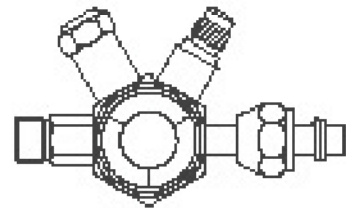

MOISTURE INDICATOR
3/8 FOR X 3/8 MIPOR,PRV,GAUGE

407518

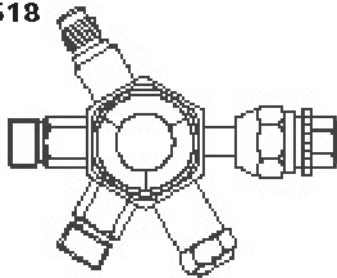

MOISTURE INDICATOR
(2) 3/8 MIPOR X 3/8 FOR,PRV,GAUGE

407519

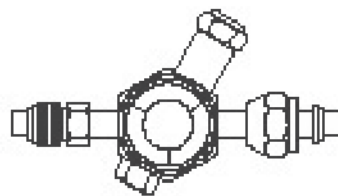

MOISTURE INDICATOR
3/8 FOR X 3/8 MOR,PRV,SW

407520

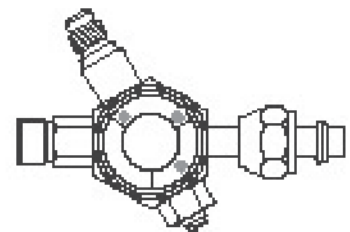

MOISTURE INDICATOR
3/8 FOR X 3/8 MIPOR,PRV,GAUGE

407521

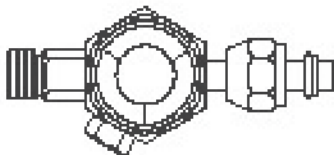

MOISTURE INDICATOR
3/8 MIPOR X 3/8 FOR,BINARY

407522

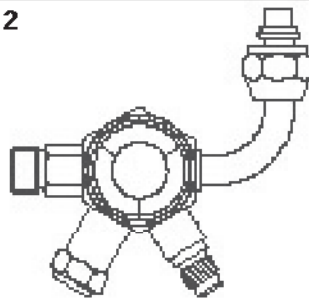

MOISTURE INDICATOR
3/8 FOR,90 X 3/8 MIPOR,PRV,GAUGE

407523

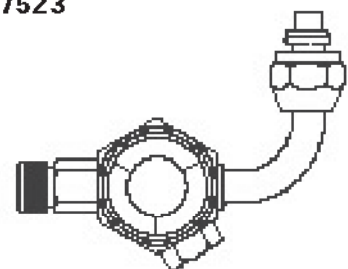

MOISTURE INDICATOR
3/8 FOR,90 X 3/8 MIPOR,SW

QUICK DISCONNECT FITTINGS

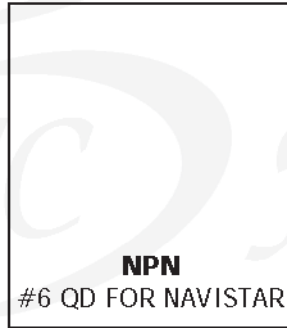

RECEIVER/DRIER MOUNTING BRACKETS

FOR DRIER
400003



102769

FOR 2.5"-4.5"
DIAMETER
RECEIVER/DRIERS



FOR 2-3/4"
DIAMETER
RECEIVER/DRIERS

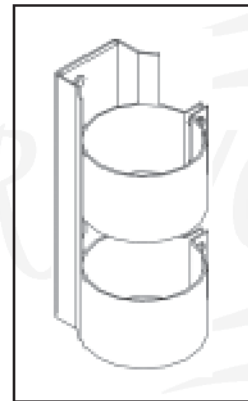

503032

FOR 2.5"-4.5"
DIAMETER
RECEIVER/DRIERS



RECEIVER/DRIERS

PARTS

5/16" BARB INLET - 5/16" BARB OUTLET

| PART # | DIAMETER | HEIGHT | MOIST IND. | SIGHT GLASS | FUSE PLUG | H. P. RELIEF VALVE | SWITCH PORT | GAUGE PORT | KEY | NOTES |
|--------|----------|--------|------------|-------------|-----------|--------------------|-------------|------------|-----|-------|
| 407000 | 2.50 | 8.00 | | X | X | | | | R12 | |
| 407007 | 2.50 | 8.00 | | | | | | | R12 | |
| 407021 | 2.50 | 8.00 | | | | | | | | |

3/8" MIOR INLET - 3/8" MIOR OUTLET (EXCEPT WHERE NOTED)

| PART # | DIAMETER | HEIGHT | MOIST IND. | SIGHT GLASS | FUSE PLUG | H. P. RELIEF VALVE | SWITCH PORT | GAUGE PORT | KEY | NOTES |
|--------|----------|--------|------------|-------------|-----------|--------------------|-------------|------------|-----|-----------------|
| 407003 | 2.50 | 6.63 | | | | | | | | 1/2" MIOR INLET |
| 407047 | 2.50 | 7.75 | | | | | | | | |
| 400003 | 2.50 | 8.00 | | X | | | | M | | |
| 407005 | 2.50 | 8.00 | | | X | | | | | |
| 407020 | 2.50 | 8.00 | | X | X | | | | | |
| 407024 | 2.50 | 8.00 | | X | X | | L | | | |
| 407057 | 2.50 | 8.75 | | | | | | | | |
| 406227 | 2.50 | 9.60 | | X | X | | | | U | |
| 407046 | 2.50 | 9.63 | | | | | | | | |
| 407038 | 2.50 | 9.75 | | | | | | | | |
| 407039 | 2.50 | 9.75 | | X | | | | | | |
| 407028 | 2.75 | 6.50 | | | X | | L | | | |
| 407029 | 2.75 | 6.50 | | | X | | | | O | |
| 407055 | 2.75 | 6.50 | | | X | | | | V | |
| 404986 | 2.75 | 10.00 | | X | | X | L | | | |
| 406152 | 2.75 | 10.00 | | X | | X | L | | | D712-248 |
| 406153 | 2.75 | 10.00 | | X | X | | L | M | | D712-225 |
| 406154 | 2.75 | 10.00 | | X | | X | L | | V | |
| 406157 | 2.75 | 10.00 | | X | | X | L | | V | |
| 406161 | 2.75 | 10.00 | | X | | X | L | | | |
| 407027 | 2.75 | 10.00 | | X | X | | | | | |
| 407036 | 2.75 | 10.00 | | X | X | | | | | |
| 407037 | 2.75 | 10.00 | | | | | | | | |
| 407063 | 2.75 | 10.00 | | | | | | | | |

DRIERS

PARTS

RECEIVER/DRIERS

3/8" MIOR INLET - 3/8" MIOR OUTLET (EXCEPT WHERE NOTED)

| PART # | DIAMETER | HEIGHT | MOIST IND. | SIGHT GLASS | FUSE PLUG | H. P. RELIEF VALVE | SWITCH PORT | GAUGE PORT | KEY | NOTES |
|--------|----------|--------|------------|-------------|-----------|--------------------|-------------|------------|-----|-------------------|
| 407064 | 2.75 | 10.00 | | X | | X | | X | | |
| 407065 | 2.75 | 10.00 | | X | X | | L | | | |
| 407066 | 2.75 | 10.00 | | X | X | | L | | | |
| 406164 | 2.75 | 10.13 | | X | | | | | | |
| 406222 | 3.00 | 5.90 | | X | X | | | | | CAT 906888 |
| 406209 | 3.00 | 6.00 | | X | X | X | L | | | |
| 407061 | 3.00 | 6.00 | X | | X | | L | | | |
| 407062 | 3.00 | 6.00 | | | | | L | | | |
| 407019 | 3.00 | 6.25 | X | | | | | | | |
| 407041 | 3.00 | 6.25 | | X | | X | L | | | |
| 406208 | 3.00 | 6.30 | | | X | | | | | |
| 406214 | 3.00 | 6.30 | | | | X | L | | | MACK 221RD32 |
| 407009 | 3.00 | 6.31 | | | X | | | | | |
| 404512 | 3.00 | 6.44 | X | X | | | | M | | |
| 406188 | 3.00 | 6.50 | | X | | X | | M | | |
| 407056 | 3.00 | 6.50 | X | X | | X | | X | | |
| 406228 | 3.00 | 6.70 | X | X | | X | L | | | |
| 407060 | 3.00 | 6.75 | X | X | X | | L | | | |
| 407054 | 3.00 | 7.38 | | X | X | | L | X | S | D712-080 |
| 407025 | 3.00 | 7.75 | | | | | L | | | |
| 407059 | 3.00 | 7.88 | X | | X | | | | | |
| 407026 | 3.00 | 8.00 | | X | X | | L | | | |
| 407071 | 3.00 | 8.00 | | | | | L | | | Ford E6HZ-19959-A |
| 406158 | 3.00 | 8.25 | | | | | | | | |
| 406159 | 3.00 | 8.25 | X | X | | X | L | | | |
| 406160 | 3.00 | 8.25 | | X | | X | L | | | |
| 407013 | 3.00 | 8.25 | | | | | | X | | |
| 407042 | 3.00 | 8.25 | X | X | X | | L | | | |
| 407072 | 3.00 | 8.25 | | | X | | L | X | | |
| 407049 | 3.00 | 8.63 | | X | | | | | | |
| 406162 | 3.00 | 9.00 | | X | X | | | M | | |
| 407048 | 3.00 | 9.00 | X | X | | | | | | |

DRIERS

RECEIVER/DRIERS

PARTS

3/8" MIOR INLET - 3/8" MIOR OUTLET (EXCEPT WHERE NOTED)

| PART # | DIAMETER | HEIGHT | MOIST IND. | SIGHT GLASS | FUSE PLUG | H. P. RELIEF VALVE | SWITCH PORT | GAUGE PORT | KEY | NOTES |
|--------|----------|--------|------------|-------------|-----------|--------------------|-------------|------------|-----|------------------------|
| 407052 | 3.00 | 9.19 | X | | | X | | | | |
| 406163 | 3.00 | 9.19 | X | X | | X | | M | | |
| 407014 | 3.00 | 9.19 | X | | | X | L | | | |
| 406092 | 3.00 | 10.00 | | X | | | | | | |
| 406165 | 3.00 | 10.13 | X | X | X | | | M | | |
| 406166 | 3.00 | 10.13 | X | X | | X | | N | | |
| 406167 | 3.00 | 10.13 | X | X | | X | | M | | |
| 407010 | 3.00 | 10.13 | | | | | | | | |
| 407011 | 3.00 | 10.13 | X | X | | X | | | | |
| 407012 | 3.00 | 10.13 | X | X | | | | X | | |
| 407030 | 3.00 | 10.13 | X | | | | | | | |
| 407058 | 3.00 | 10.13 | X | X | | | | | | |
| 407034 | 3.00 | 10.25 | X | X | | | | | | |
| 407053 | 4.00 | 5.00 | | | X | | | | | |
| 406221 | 4.00 | 7.20 | | | X | | | | Q | |
| 406547 | 4.00 | 7.20 | | | | | | | | |
| 406217 | 4.00 | 7.80 | X | | | X | | | S | CAT 106-5534CAT 5V5659 |
| 406218 | 4.00 | 7.80 | | X | | X | L | | | |
| 407022 | 4.00 | 8.00 | | | | | | | | |

3/8" MIOR INLET - 3/8" FOR OUTLET

| PART # | DIAMETER | HEIGHT | MOIST IND. | SIGHT GLASS | FUSE PLUG | H. P. RELIEF VALVE | SWITCH PORT | GAUGE PORT | KEY | NOTES |
|--------|----------|--------|------------|-------------|-----------|--------------------|-------------|------------|-----|---------------------------|
| 406168 | 3.00 | 8.25 | X | X | | X | | M | | 2 Ports |
| 407015 | 3.00 | 8.25 | | | | X | | X | | |
| 407018 | 3.00 | 8.25 | X | | | X | | X | | |
| 407035 | 3.00 | 8.25 | X | X | | | | X | | |
| 407070 | 3.00 | 8.25 | X | X | X | X | L | | M | Freightliner A22-32150-00 |
| 406169 | 3.00 | 10.13 | X | X | | | | N | | |
| 407016 | 3.00 | 10.13 | X | | | | | X | | |
| 407031 | 3.00 | 10.13 | X | X | | X | | X | | |

PARTS

RECEIVER/DRIERS

3/8" Male Flare INLET - 3/8" Male Flare OUTLET

| PART # | DIAMETER | HEIGHT | MOIST IND. | SIGHT GLASS | FUSE PLUG | H. P. RELIEF VALVE | SWITCH PORT | GAUGE PORT | KEY | NOTES |
|--------|----------|--------|------------|-------------|-----------|--------------------|-------------|------------|-----|----------------------------------|
| 407006 | 2.50 | 6.00 | | | X | | | | R12 | |
| 407001 | 2.50 | 6.75 | | | X | | | | R12 | |
| 404804 | 2.50 | 8.00 | | X | | | | | | |
| 407002 | 2.50 | 8.00 | | | X | | | | | |
| 407045 | 3.00 | 6.00 | | X | X | | | | | |
| 407068 | 3.00 | 9.50 | | X | X | | | | R12 | |
| 407050 | 3.00 | 11.00 | | | | | | | | |
| 407051 | 4.00 | 6.88 | | X | | | | | | Navistar 539049 |
| 406225 | 4.00 | 7.80 | | | X | | | | | CAT 6P130NH 620206SIGNET 2-17948 |
| 407075 | 4.00 | 8.00 | | X | X | | | | | |

7/16" FOR INLET - 3/8" FOR OUTLET

| PART # | DIAMETER | HEIGHT | MOIST IND. | SIGHT GLASS | FUSE PLUG | H. P. RELIEF VALVE | SWITCH PORT | GAUGE PORT | KEY | NOTES |
|--------|----------|--------|------------|-------------|-----------|--------------------|-------------|------------|-----|-------|
| 407033 | 3.00 | 8.50 | | X | | | | | | |
| 406172 | 3.00 | 10.09 | | | | | | | | |
| 406171 | 3.00 | 10.13 | | | | X | | | | |
| 407023 | 3.00 | 10.50 | X | | X | | L | | | |

PAD-NIPPONDENSO

| PART # | DIAMETER | HEIGHT | MOIST IND. | SIGHT GLASS | FUSE PLUG | H. P. RELIEF VALVE | SWITCH PORT | GAUGE PORT | KEY | NOTES |
|--------|----------|--------|------------|-------------|-----------|--------------------|-------------|------------|-----|-----------------------|
| 406378 | 2.50 | 9.30 | | | | | | | | KOMATSU #20Y-979-3120 |

DRIERS

RECEIVER/DRIERS

PARTS

3/8" FOR INLET - 3/8" MIOR OUTLET

| PART # | DIAMETER | HEIGHT | MOIST IND. | SIGHT GLASS | FUSE PLUG | H. P. RELIEF VALVE | SWITCH PORT | GAUGE PORT | KEY | NOTES |
|--------|----------|--------|------------|-------------|-----------|--------------------|-------------|------------|-----|---------------------------|
| 406170 | 3.00 | 10.13 | X | X | | | | | | |
| 406223 | 4.00 | 6.80 | | X | X | | | | R | IH 118418-C1 IH 118304-C1 |
| 406224 | 4.00 | 7.50 | | X | | | | | U | JD RE49169 |
| 407032 | 4.00 | 7.50 | | X | | | | | | |
| 407073 | 4.00 | 7.50 | | X | | | | | | |
| 407074 | 4.00 | 7.75 | | X | | | | | | |
| 406276 | 4.00 | 7.77 | | | | | | | U | CASE 1990758C2 |
| 406279 | 4.00 | 8.00 | | | | | | | | |
| 406216 | 4.00 | 9.00 | X | X | | | | | | JD AT162848 |
| 407076 | 4.00 | 9.00 | | X | | | | | | |
| 407077 | 4.00 | 9.00 | | X | | | | | | |

QUICK DISCONNECT

| PART # | DIAMETER | HEIGHT | MOIST IND. | SIGHT GLASS | FUSE PLUG | H. P. RELIEF VALVE | SWITCH PORT | GAUGE PORT | KEY | NOTES |
|--------|----------|--------|------------|-------------|-----------|--------------------|-------------|------------|-----|-------------------------|
| 407017 | 2.50 | 6.00 | X | | | | | X | | |
| 406229 | 2.50 | 9.60 | | | | | | | U | PB 18-03841 |
| 407008 | 2.50 | 9.63 | | | | | | | | |
| 407004 | 2.50 | 10.75 | | | X | | | X | R12 | |
| 406210 | 2.50 | 13.80 | X | | | | | | U | CAT 3E3535 |
| 407067 | 3.00 | 10.00 | X | X | X | X | | | | |
| 407069 | 3.00 | 10.10 | X | | | X | L | | | Navistar 1619412C1 |
| 407043 | 3.00 | 10.13 | X | X | X | X | | X | | |
| 407044 | 3.00 | 10.13 | X | | | X | | X | | |
| 406219 | 4.00 | 7.80 | | | | X | L | | | CAT 106-5532 |
| 406220 | 4.00 | 7.80 | X | | | X | | | S | CAT 106-5533 CAT 9W0549 |

DRIERS

PARTS

RECEIVER/DRIERS

3/4" FOR INLET - 3/4" MIOR OUTLET

| PART # | DIAMETER | HEIGHT | MOIST IND. | SIGHT GLASS | FUSE PLUG | H. P. RELIEF VALVE | SWITCH PORT | GAUGE PORT | KEY | NOTES |
|--------|----------|--------|------------|-------------|-----------|--------------------|-------------|------------|-----|-------|
| 407078 | 3.00 | 8.50 | | | | | 2 | | M | |
| 407091 | 3.50 | 9.00 | | | | | 2 | | | |
| 407079 | 3.50 | 9.50 | | | | | L | | | |
| 407080 | 3.50 | 9.50 | | | | | 2 | | M | |
| 407081 | 3.50 | 9.50 | | | | | L | | | |
| 407082 | 3.50 | 9.50 | | | | | | | | |
| 407083 | 3.50 | 9.50 | | | | | L | | | |
| 407084 | 3.50 | 9.50 | | | | | 2 | | | |
| 407085 | 3.50 | 9.50 | | | | | 2 | | | |
| 407086 | 3.50 | 9.50 | | | | | 2 | | | |
| 407087 | 3.50 | 9.50 | | | | | 2 | | | |
| 407088 | 3.50 | 9.50 | | | | | L | | | |
| 407090 | 3.50 | 9.50 | | | | | 2 | | | |
| 407092 | 3.50 | 10.00 | | | | | L | | | |

5/8" MOR INLET - 5/8" MOR OUTLET

| PART # | DIAMETER | HEIGHT | MOIST IND. | SIGHT GLASS | FUSE PLUG | H. P. RELIEF VALVE | SWITCH PORT | GAUGE PORT | KEY | NOTES |
|--------|----------|--------|------------|-------------|-----------|--------------------|-------------|------------|-----|-------|
| 407093 | 3.50 | 10.00 | | | | | 2 | | | |
| 407094 | 3.50 | 10.00 | | | | | 2 | | | |

3/4" FOR INLET - 3/4" FOR OUTLET

| PART # | DIAMETER | HEIGHT | MOIST IND. | SIGHT GLASS | FUSE PLUG | H. P. RELIEF VALVE | SWITCH PORT | GAUGE PORT | KEY | NOTES |
|----------|----------|--------|------------|-------------|-----------|--------------------|-------------|------------|-----|--------------|
| 406093 | 3.50 | 8.00 | | | | | 2 | | | |
| D706-514 | 3.50 | 9.50 | | | | | | | | CAT 151-5261 |

DRIERS

MISCELLANEOUS ACCUMULATORS

| PART # | INLET FTG | OUTLET FTG | DIAMETER | HEIGHT | SWITCH PORT | GAUGE PORT | KEY | NOTES |
|--------|-------------|-------------|----------|--------|-------------|------------|-----|-------|
| 407098 | 1-1/16" FOR | 1-1/16" FOR | 3.75 | 9.25 | | | | |
| 406230 | PAD-PB | PAD-PB | 3.50 | 8.00 | | | | |
| 407089 | M27 FOR | M27 MOR | 3.50 | 9.00 | L | | | |
| 407095 | 3/4" MSPRLK | 3/4" MSPRLK | 3.50 | 12.00 | L | | | |
| 407097 | 5/8" MSPRLK | 5/8" MSPRLK | 3.50 | 8.75 | | X | | |
| 407096 | 5/8" FSPRLK | 5/8" FSPRLK | 3.50 | 8.00 | 2 | | | |

KEY

- | | |
|--|---------------------------------------|
| L 3/8-24 O-RING | R SIDE MOUNTED SIGHT GLASS |
| M 7/16-20 MALE SCHRADER | S INCLUDES LOW PRESSURE SWITCH |
| N M10 FITTING | T 2 SIGHT GLASSES |
| O INCLUDES BINARY SWITCH | U HORIZONTAL TYPE DRIER |
| P INCLUDES HIGH PRESSURE SWITCH | V INCLUDES TRINARY SWITCH |
| Q SIDE INLET FITTING | |